

- Ⓜ GB Fixing Anchors
- Ⓜ D Hülsenanker
- Ⓜ F Douilles de fixations
- Ⓜ ES Casquillos de fijación
- Ⓜ NL Bevestigingsankers
- Ⓜ PL Kotwy tulejowe



Assembly Instructions • Montageanleitung • Notice d'utilisation • Instrucciones de montaje •
 Montagehandleiding • Instrukcja montażu

Anchor types

This assembly instruction is valid for the following anchor types of DEMU Fixing anchors:

T-FIXX®
(GV, A4)



Bar anchor

types 4010 (GV, FV), 4030 (GV, FV), 3016 (GV), 3010 (A4-80), 1980-S (GV), 1988-S (GV), 1554 (GV, FV, A4-80), 1558 (GV, FV, A4-80)



Bolt anchor

types 1988 (GV, FV, A4-50, A4-80), 1985 (GV), 1980-P (GV, FV, A4-80)



Socket anchor

types 995-GB (GV), 995 (A4), 995-G (GV, A4), 995-DG (GV), 1036-G (GV, A4), 1130 (GV), 1140 (GV, A4)



General notes on installation

In order to guarantee best possible bond between the fixing anchor and the concrete, make sure that the surface of the anchor is free from dirt, oil, etc.

The concrete has to be poured carefully; please avoid direct contact between the compacting device and the fixing anchor. Additional securing of the anchors by wire-tying is recommended.

The fixing anchors may be embedded flush or recessed in the concrete. It is strongly recommended to use washers to shim if anchors are recessed.

Shortly after striking the formwork the nailing plates should be removed. **The inside of the threaded socket must be**

dry and further protected against ingress of water, dirt or oil until required for use i.e. for fixing components. Ensure the inside of the socket remains dry after final assembly.

The fixing component (bolt with standard metric thread) has to be selected according to the static engineer's specifications. Minimum / maximum screw-in length for bolts and maximum installation torque moment (T_{inst}) can be found on pages 6 - 7.

The fixing anchor must not be subjected to full load capacity until the concrete has reached its final strength.

Welding

All DEMU-products shown in our Technical Product Information „DEMU FIX“ are weldable. However, any welding, including tack welding, to DEMU-products can negatively influence their mechanical properties. Welding can affect the performance of the product.

If welding in the application is unavoidable, take the following into account:

- a possible change in performance; a possible reduction in load capacity
- remove any coating layer before welding, and ensure welding fumes are safely extracted during welding
- use mandatory protective equipment
- the customer is responsible for making sure that applicable welding regulations are respected

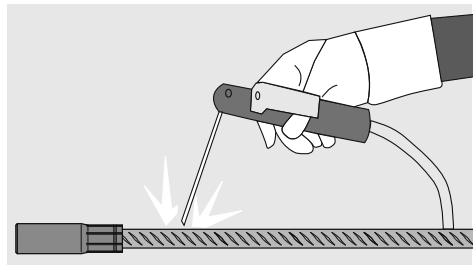

HALFEN is not liable for any damage caused to or by DEMU products that have been subsequently welded.

Assembly of accessories

Nailing plate

Type 2275 (h=2mm)



Type 2280 (h=10mm)



Fixing pin

Type 2250



Sealing cap

Type 2244



Thread adapter

Type 2600



Available thread sizes: M8 – M30

d_{nom}	M8*	M10	M12	M16	M20	M24	M30*
* only type 2280 available							

Figure 1

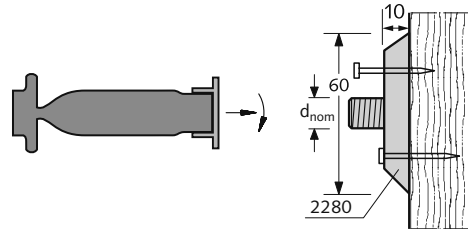

Available thread sizes: M6 – M24

d_{nom}	M6	M8	M10	M12	M16	M20	M24
\varnothing drilling hole [mm]	11	11	11	11	17	17	17

Figure 2

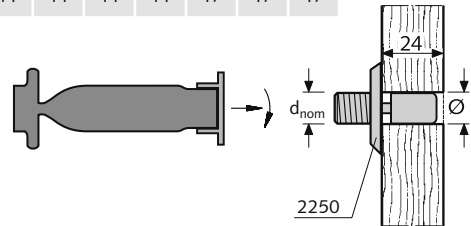

Available thread sizes: M6 – M42

d_{nom}	M6	M8	M10	M12	M16	M20	M24	M30	M36	M42
-----------	----	----	-----	-----	-----	-----	-----	-----	-----	-----

Figure 3

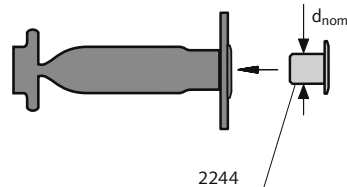

Available thread sizes: M12 – M42

d_{nom}	M12	M16	M20	M24	M30	M36	M42
d_B fixing bolt	M6	M8	M8	M10	M10	M10	M12

Figure 4

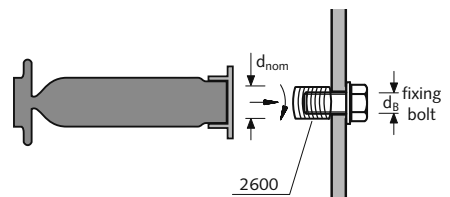

English

Deutsch

Français

Español

Nederlands

Polski

Assembly steps (shown: T-FIXX; fixing of other anchor types analogical)

English

Deutsch

Français

Español

Nederlands

Polski

Fixing to the formwork

Preparing for assembly

Screw-in and fixing of the bolt ①

Case A
with plastic nailing plate

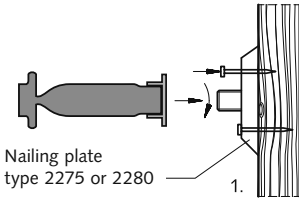

Nailing plate
type 2275 or 2280

Assembly of nailing plate:
see page 3, figure 1

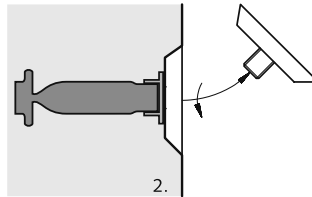

Remove formwork,
unscrew nailing plate

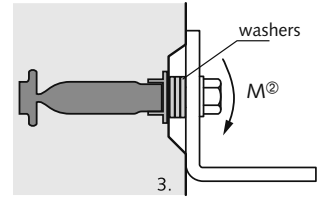

Case B
with plastic fixing pin

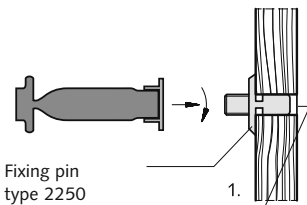

Fixing pin
type 2250

Drill hole in formwork:
see page 3, figure 2

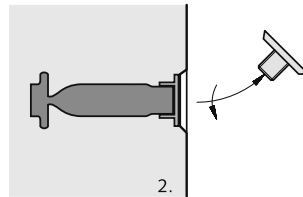

Remove formwork,
unscrew remainder of fixing pin

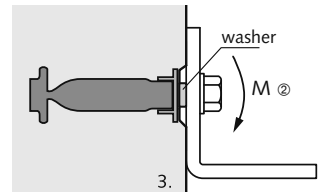

Case C
Fixing anchors with integrated nailing plate

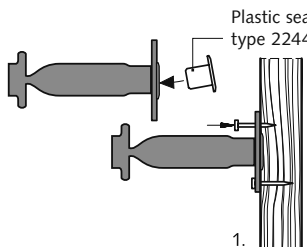

Fixing of sealing cap:
see page 3, figure 3

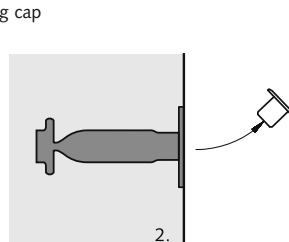

Remove formwork,
remove sealing cap

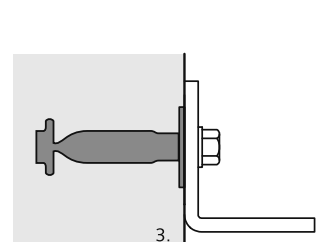

① Torque moment T_{inst} → see table on page 6

② Bending of bolt has to be verified by customer! (Bolt is not included in scope of delivery)

Assembly steps (shown: T-FIXX; fixing of other anchor types analogical)

Fixing to the formwork

Preparing for assembly

Screw-in and fixing of the bolt ①

Case D
with hexagonal bolt

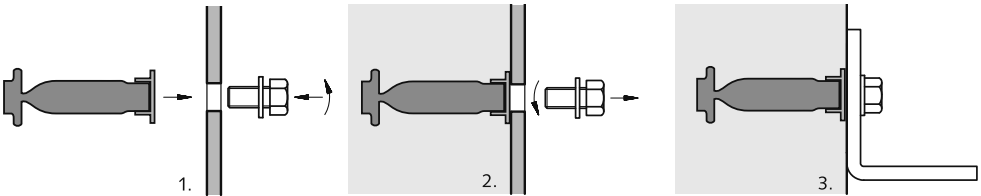

Unscrew hexagonal bolt,
remove formwork

Case E
with thread adapter and hexagonal bolt

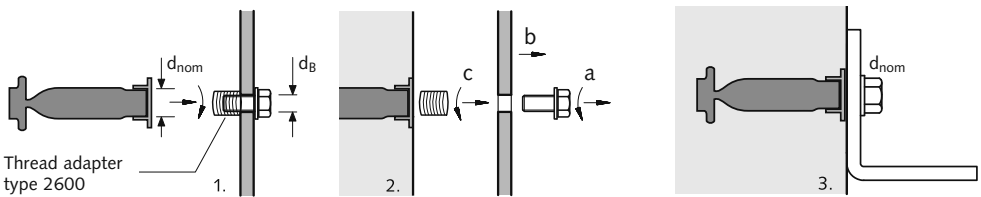

Thread adapter
type 2600

Assembly of thread adapter:
see page 3, figure 4

a) unscrew hexagonal bolt,
b) remove formwork,
c) thread adapter

Case F
with magnetic fixing plate on steel formwork

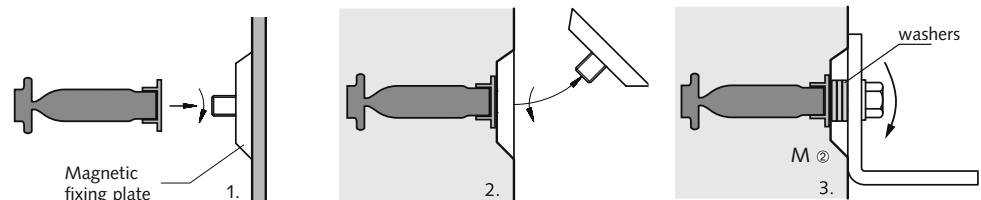

Remove formwork,
Unscrew magnetic fixing plate

① Torque moment T_{inst} → see table on page 6

② Bending of bolt has to be verified by customer! (Bolt is not included in scope of delivery)

Torque moment T_{inst} [Nm]*			
Thread-size	T-FIXX®	Bolt anchors / Bar anchors	Socket anchors
M10	≤ 8	-	≤ 4
M12	≤ 10	≤ 10	≤ 8
M16	≤ 30	≤ 30	≤ 17
M20	≤ 60	≤ 50	≤ 25
M24	-	≤ 90	≤ 53
M30	-	≤ 180	≤ 96
M36	-	≤ 250	-
M42	-	≤ 300	-

* Tightening torque values apply only to bolts in unlubricated condition.

Determining bolt length

General

The fixture is attached to the cast-in anchor with a standard metric thread fastening bolt and washer or a threaded rod, a washer and a nut. The fixing components are not included with the DEMU Fixing systems and have to be ordered separately. The fixing component (bolt) has to be selected according to the static engineer's specifications.

Screw-in length of bolt

For all fixing anchors there is a minimum and a maximum screw-in length. Minimum values can be found in the table below. The corresponding maximum values for each type can be found in the tables next page. To find the required bolt length, proceed as described below.

Determining the required bolt length (L_s)

Bolt length (L_s)
 $L_{s,min}$ = $s + k$ (minimum bolt length)
 $L_{s,max}$ = $a + k$ (maximum bolt length)

- k = clamp thickness (thickness of the steel angle support and the washers)
- s = minimum screw-in length (→ see table below)
- a = maximum screw-in length (→ see tables on page 7)

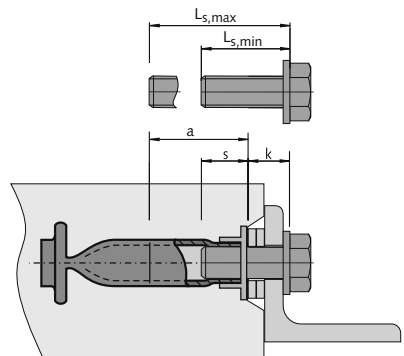

Minimum screw-in length s [mm]

Thread-size	T-FIXX®	Bolt anchor 1988	Bolt anchors 1985/1980-P / Bar anchors / Socket anchors ①,②
M6	-	-	7.2
M8	-	-	9.6
M10	17.0	-	12.0 / 15.0
M12	20.0	16.4	14.4 / 18.0
M16	26.0	21.2	19.2 / 24.0
M20	32.0	26.0	24.0 / 30.0
M24	-	30.8	28.8 / 36.0
M30	-	38.0	36.0
M36	-	45.2	43.2
M42	-	52.4	50.4

① value $s = 1.2 \times d_{nom}$
 ② higher values ($s = 1.5 \times d_{nom}$) apply for fixing anchors with integrated nailing plate → types 1985 (GV), 1036-G (GV, A4) and 1130 (GV).

Maximum screw-in length a [mm] for T-FIXX® ①		
Thread-size / anchor-type		a [mm]
M10	all types	32.0
	M 12 × 50	30.0
M12	M 12 × 70	28.0
	M 12 × 95	
	M 12 × 115	
	M 16 × 60	
M16	M 16 × 80	50.0
	M 16 × 100	
	M 16 × 110	
	M 16 × 125	
	M 20 × 70	
M20	M 20 × 100	62.0
	M 20 × 125	
	M 20 × 145	

① for type T-FIXX® (GV, A4)

Maximum screw-in length a [mm] for Bolt anchors / Bar anchors ②, ③	
Thread-size	a [mm]
M12	23.0
M16	29.0
M20	35.0
M24	46.0
M30	60.0
M36	74.0
M42	68.0

② for following types:
 1985 (GV)
 1980-P (GV, FV, A4-80)
 3016 (GV)
 3010 (A4-80)
 1980-S (GV)
 1988-S (GV)
 1554 (GV, FV, A4-80)
 1558 (GV, FV, A4-80)

Thread-size	4010/4030	1988*
	a [mm]	a [mm]
M12	-	25.0
M16	25.0	31.0
M20	33.0	37.0
M24	38.0	48.0
M30	48.0	62.0
M36	-	76.0
M42	65.0	70.0

③ for following types:
 1988 (GV, FV, A4-50, A4-80)
 4010 (GV, FV)
 4030 (GV, FV)

* for bolt anchors with special sealing on bottom of the sleeve (types A4-50, A4-80), the values have to be decreased by 3.0 mm.

Maximum screw-in length a [mm] for Socket anchors ④-⑧		
Thread-size / anchor-type		a [mm]
M6	M 6 × 30	14.0
	M 6 × 40	20.0
M8	M 8 × 40	18.0
	M 8 × 50	25.0

④ for type 995-GB (GV)

Thread-size / anchor-type		a [mm]
M6	M 6 × 40	25.0

⑤ for type 995 (A4)

Thread-size / anchor-type		a [mm]
M8	M 8 × 50	20.0
M10	M 10 × 50	
M12	M 12 × 60 (GV)	23.0
	M 12 × 60 (A4)	25.0
	M 12 × 70	30.0
M16	M 16 × 70	25.0
	M 16 × 80	
	M 16 × 100 (A4)	
	M 16 × 100 (GV)	
	M 16 × 120	
M20	M 20 × 100	40.0
	M 20 × 120	
M24	M 24 × 120	50.0
M30	M 30 × 150	70.0

⑥ for following types:
 995-G (GV, A4)
 1036-G (GV, A4)

Thread-size / anchor-type		a [mm]
M8	M 8 × 50	30.0
M10	M 10 × 60	35.0
M12	M 12 × 45	18.0
	M 12 × 70	40.0
M16	M 16 × 60	24.0
	M 16 × 100	32.0
M20	M 20 × 70	30.0
	M 20 × 100	40.0
M24	M 24 × 80	24.0

⑦ for following types:
 1130 (GV)
 1140 (GV, A4)

Thread-size / anchor-type		a [mm]
M12	M 12 × 60	22.0
M16	M 16 × 75	22.0
	M 16 × 100	35.0
M20	M 20 × 90	25.0
	M 20 × 120	45.0
M24	M 24 × 100	30.0
M30	M 30 × 135	35.0

⑧ for type 995-DG (GV)

Ankertypen

Diese Montageanleitung ist für folgende Ankertypen der DEMU Hülsenanker gültig:

T-FIXX®
(GV, A4)



Stabanker

Typen 4010 (GV, FV), 4030 (GV, FV), 3016 (GV), 3010 (A4-80), 1980-S (GV), 1988-S (GV), 1554 (GV, FV, A4-80), 1558 (GV, FV, A4-80)



Bolzenanker

Typen 1988 (GV, FV, A4-50, A4-80), 1985 (GV), 1980-P (GV, FV, A4-80)



Typ1988
Typ1985

Ankerhülsen

Typen 995-GB (GV), 995 (A4), 995-G (GV, A4), 995-DG (GV), 1036-G (GV, A4), 1130 (GV), 1140 (GV, A4)



Allgemeine Einbauhinweise

Damit ein sauberer Verbund zwischen Hülsenanker und Beton gewährleistet werden kann, ist sicherzustellen, dass der Anker nicht mit Fremdkörpern, Öl, etc. verschmutzt ist. Der Beton sollte sorgsam eingebracht werden, der direkte Kontakt zwischen Rüttler und Anker ist zu vermeiden. Zusätzliches Anrödeln der Anker an die Bewehrung ist zu empfehlen.

Hülsenanker können oberflächenbündig oder vertieft eingebaut werden. Im Fall von zurückversetzt eingebauten Anker sind bei Befestigung des Anbauteils Unterlegscheiben zur Unterfütterung zu verwenden.

Unmittelbar nach dem Ausschalen sollten die Nagelteller herausgedreht werden. **Das Innere der Gewindehülse hat dann bis zur Verwendung, d. h. bis zur Befestigung des**

Anbauteils, gegen Eindringen von Wasser, Verunreinigungen oder Öl geschützt zu werden und trocken zu sein. Auch nach der Endmontage ist sicherzustellen, dass kein Wasser in die Gewindehülse eindringt.

Zur Befestigung des Anbauteils sind die in den Konstruktionsunterlagen des verantwortlichen Planers vorgeschriebenen Schrauben zu verwenden.

Die minimalen / maximalen Einschraubtiefen der Befestigungsschrauben in die Gewindehülsen sowie die maximalen Installationsdrehmomente (T_{inst}) sind gemäß den Tabellen auf den Seiten 12 - 13 einzuhalten.

Die Belastung des Hülsenankers darf erst nach Erreichen der vorgesehenen Betonfestigkeit erfolgen.

Schweißbarkeit

Alle im Katalog „DEMU FIX“ aufgeführten DEMU-Produkte (aus Stahl) sind grundsätzlich schweißbar. Allerdings kann jede Form von Schweißen, einschließlich Heftschweißen, die mechanischen Eigenschaften der DEMU-Produkte beeinträchtigen.

Sollte sich in speziellen Anwendungsfällen Schweißen nicht vermeiden lassen, so ist folgendes unbedingt zu beachten:

- Eingeschränkte Funktionsfähigkeit sowie verminderte Tragfähigkeit können eintreten.
- Evtl. vorhandene Beschichtungen sind vor dem Schweißen zu entfernen; durch den Schweißvorgang auftretende Dämpfe sind mit geeignetem Gerät abzusaugen.
- Es ist die vorgeschriebene Schutzausrüstung zu tragen.
- Der Kunde ist verantwortlich für die Einhaltung der geltenden Vorschriften bzgl. des Schweißvorgangs.

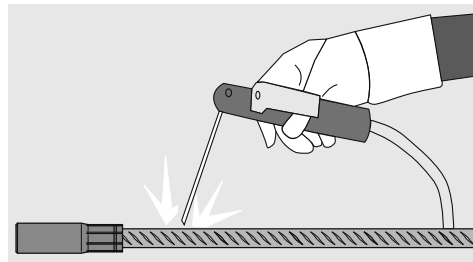

HALFEN übernimmt keinerlei Haftung für Schäden durch DEMU-Produkte bzw. an DEMU-Produkten, die geschweißt wurden.

Montage des Zubehörs

Haltescheibe

Typ 2275 (h=2mm)



Typ 2280 (h=10mm)



Montage-Bruchdübel

Typ 2250



Verschlussstopfen

Typ 2244



Gewindeadapter

Typ 2600



Verfügbare Gewindegrößen: M8 – M30

d_{nom}	M8*	M10	M12	M16	M20	M24	M30*
* nur Typ 2280 lieferbar							

Abbildung 1

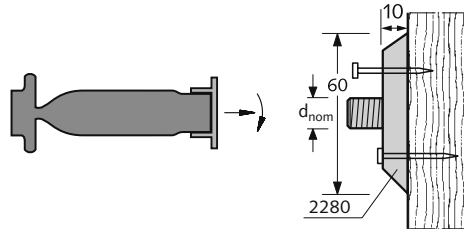

Verfügbare Gewindegrößen: M6 – M24

d_{nom}	M6	M8	M10	M12	M16	M20	M24
\varnothing Bohrloch [mm]	11	11	11	11	17	17	17

Abbildung 2

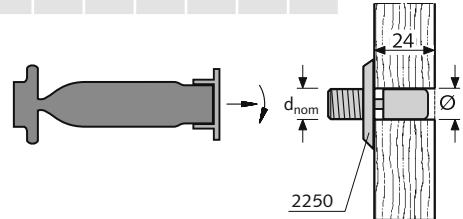

Verfügbare Gewindegrößen: M6 – M42

d_{nom}	M6	M8	M10	M12	M16	M20	M24	M30	M36	M42
-----------	----	----	-----	-----	-----	-----	-----	-----	-----	-----

Abbildung 3

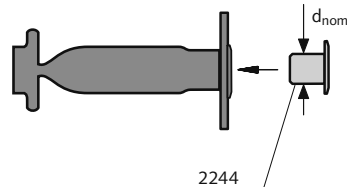

Verfügbare Gewindegrößen: M12 – M42

d_{nom}	M12	M16	M20	M24	M30	M36	M42
d_B Schraube	M6	M8	M8	M10	M10	M10	M12

Abbildung 4

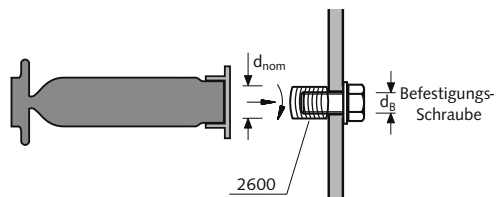

Montagschritte (Abbildung: T-FIXX; Befestigung der anderen Hülseankertypen analog)

English

Deutsch

Français

Español

Nederlands

Polski

Befestigung an der Schalung

Vorbereitung zur Montage

Schraube eindrehen und festziehen ①

Fall A
mit Kunststoff-Haltescheibe

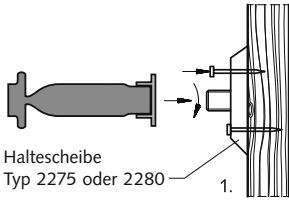

Haltescheibe
Typ 2275 oder 2280

Haltescheibe festnageln:
siehe Seite 9, Abbildung 1

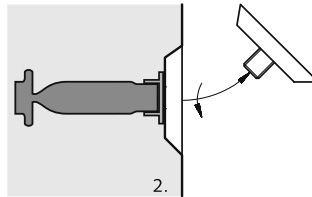

Schalung entfernen,
Haltescheibe herausdrehen

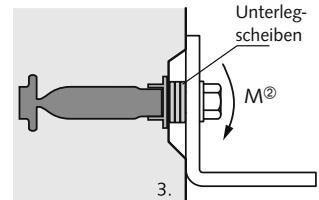

Fall B
mit Montage-Bruchdübel

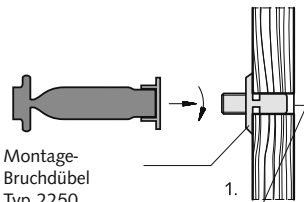

Montage-
Bruchdübel
Typ 2250

Bohrloch in Schalung:
siehe Seite 9, Abbildung 2

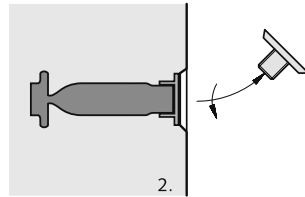

Schalung entfernen,
Gewindeteil herausdrehen

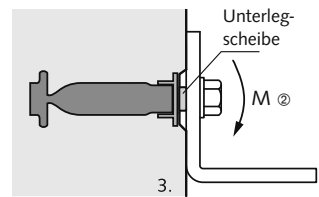

Fall C
Hülseanker mit integriertem Nagelflansch

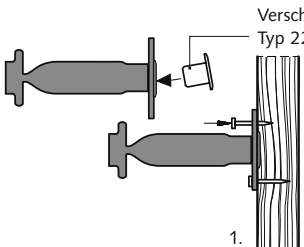

Verschlussstopfen
Typ 2244

Verschlussstopfen in Hülseanker
einsetzen:
siehe Seite 9, Abbildung 3

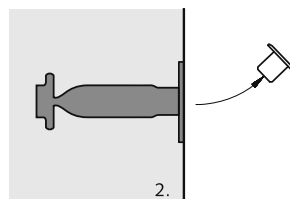

Schalung entfernen,
Verschlussstopfen entfernen

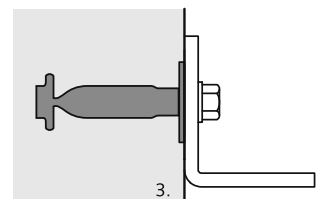

- ① Anzugsdrehmomente T_{inst} → siehe Tabelle auf Seite 12
- ② Schraubenbiegung infolge der rückversetzten Lage des Hülseankers ist zu berücksichtigen und bauseits nachzuweisen (Schrauben nicht im Lieferumfang enthalten)

Montagschritte (Abbildung: T-FIXX; Befestigung der anderen Hülsenakertypen analog)

Befestigung an der Schalung

Vorbereitung zur Montage

Schraube eindrehen und festziehen ①

Fall D
mit Sechskantschraube

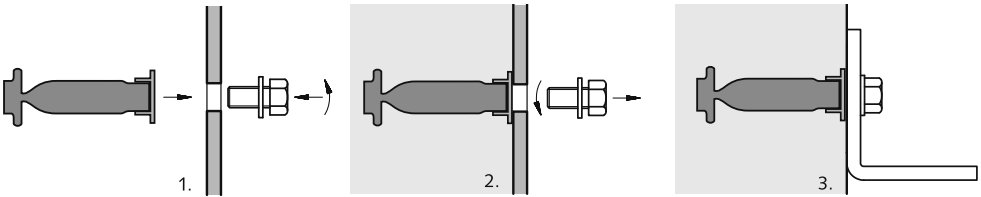

Sechskantschraube herausdrehen,
Schalung entfernen

Fall E
mit Gewintheadapter und Sechskantschraube

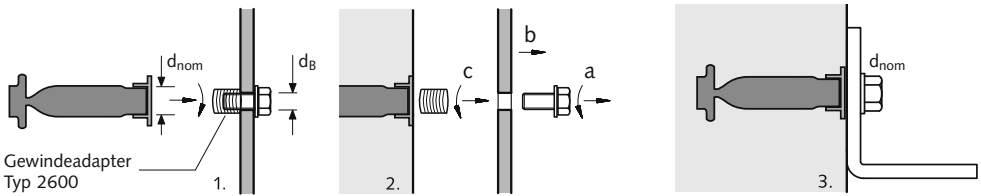

Gewintheadapter
Typ 2600

Gewintheadapter fixieren:
siehe Seite 9, Abbildung 4

- a) Sechskantschraube herausdrehen,
- b) Schalung entfernen,
- c) Gewintheadapter herausdrehen

Fall F
mit Magnethalter auf Stahlchalung

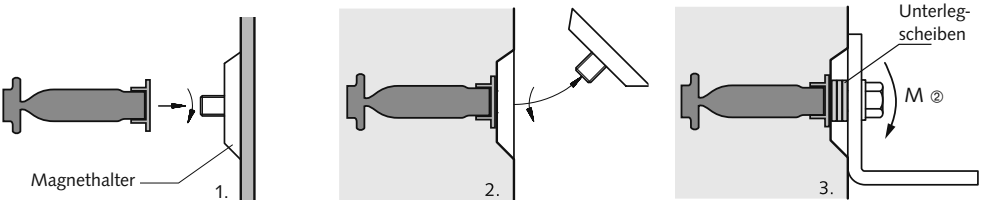

Schalung entfernen,
Magnethalter herausdrehen

① Anzugsdrehmomente T_{inst} → siehe Tabelle auf Seite 12

② Schraubenbiegung infolge der rückversetzten Lage des Hülsenankers ist zu berücksichtigen und bauseits nachzuweisen (Schrauben nicht im Lieferumfang enthalten)

Drehmoment T_{inst} [Nm]*

Gewindegröße	T-FIXX®	Bolzenanker / Stabanker	Ankerhülsen
M10	≤ 8	-	≤ 4
M12	≤ 10	≤ 10	≤ 8
M16	≤ 30	≤ 30	≤ 17
M20	≤ 60	≤ 50	≤ 25
M24	-	≤ 90	≤ 53
M30	-	≤ 180	≤ 96
M36	-	≤ 250	-
M42	-	≤ 300	-

* Die Anzugsmomente gelten nur für Schrauben im ungeschmierten Zustand.

Ermittlung der erforderlichen Schraubenlänge

Allgemeines

Das Einbauteil wird mit einer Befestigungsschraube mit metrischem Regelgewinde und Unterlegscheibe bzw. mit Gewindestange, Unterlegscheibe und Kontermutter im einbetonierten Hülsenanker befestigt. Die genannten Befestigungskomponenten sind nicht im Lieferumfang enthalten und müssen separat bestellt bzw. vorgehalten werden. Es sind Schrauben gemäß den Vorgaben des verantwortlichen Planers zu verwenden.

Einschraublänge

Bei der Verwendung der Hülsenanker sind die minimalen und maximalen Einschraublängen zu beachten. Die Mindesteinschraublängen sind in der Tabelle unten zusammengefasst. Die entsprechenden maximalen Werte sind den Tabellen auf der folgenden Seite zu entnehmen. Die Ermittlung der erforderlichen Schraubenlängen ist im folgenden Abschnitt beschrieben.

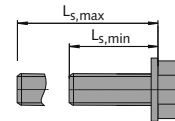

Ermittlung der erforderlichen Schraubenlänge (L_s)

Schraubenlänge (L_s)

$L_{s,min}$ = $s + k$ (minimale Schraubenlänge)

$L_{s,max}$ = $a + k$ (maximale Schraubenlänge)

- k = Klemmdicke (Dicke des Anbauteils und der Unterlegscheiben)
- s = minimale Einschraublänge (→ siehe Tabelle unten)
- a = maximale Einschraublänge (→ siehe Tabellen auf Seite 13)

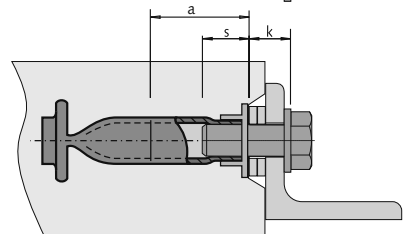

Minimale Einschraublänge s [mm]

Gewindegröße	T-FIXX®	Bolzenanker 1988	Bolzenanker 1985/1980-P / Stabanker / Ankerhülsen ①, ②
M6	-	-	7,2
M8	-	-	9,6
M10	17,0	-	12,0 / 15,0
M12	19,0	16,4	14,4 / 18,0
M16	26,0	21,2	19,2 / 24,0
M20	32,0	26,0	24,0 / 30,0
M24	-	30,8	28,8 / 36,0
M30	-	38,0	36,0
M36	-	45,2	43,2
M42	-	52,4	50,4

① $s = 1,2 \times d_{nom}$

② größere Werte ($s = 1,5 \times d_{nom}$) gelten für Hülsenanker mit integriertem Nagelflansch → Typen 1985 (GV), 1036-G (GV, A4) und 1130 (GV).

Maximale Einschraublänge a [mm] für T-FIXX® ①		
Gewindegröße / Ankerabmessung		a [mm]
M10	alle Größen	32,0
	M 12 × 50	30,0
M12	M 12 × 70	28,0
	M 12 × 95	
	M 12 × 115	
	M 16 × 60	
M16	M 16 × 80	50,0
	M 16 × 100	
	M 16 × 110	
	M 16 × 125	
	M 20 × 70	
M20	M 20 × 100	44,0
	M 20 × 125	62,0
	M 20 × 145	
	M 20 × 145	

① für Typ T-FIXX® (GV, A4)

Maximale Einschraublänge a [mm] für Bolzenanker / Stabanker ②,③	
Gewindegröße	a [mm]
M12	23,0
M16	29,0
M20	35,0
M24	46,0
M30	60,0
M36	74,0
M42	68,0

② für folgende Typen:
 1985 (GV)
 1980-P (GV, FV, A4-80)
 3016 (GV)
 3010 (A4-80)
 1980-S (GV)
 1988-S (GV)
 1554 (GV, FV, A4-80)
 1558 (GV, FV, A4-80)

Gewindegröße	4010/4030	1988*
	a [mm]	a [mm]
M12	-	25,0
M16	25,0	31,0
M20	33,0	37,0
M24	38,0	48,0
M30	48,0	62,0
M36	-	76,0
M42	65,0	70,0

③ für folgende Typen:
 1988 (GV, FV, A4-50, A4-80)
 4010 (GV, FV)
 4030 (GV, FV)

* Für Bolzenanker mit versiegeltem Hülsenboden (Typen A4-50, A4-80) sind die Werte um 3 mm abzumindern.

Maximale Einschraublänge a [mm] für Ankerhülsen ④-⑥		
Gewindegröße / Ankerabmessung		a [mm]
M6	M 6 × 30	14,0
	M 6 × 40	20,0
M8	M 8 × 40	18,0
	M 8 × 50	25,0

④ für Typ 995-GB (GV)

Gewindegröße / Ankerabmessung		a [mm]
M6	M 6 × 40	25,0

⑤ für Typ 995 (A4)

Gewindegröße / Ankerabmessung		a [mm]
M8	M 8 × 50	20,0
M10	M 10 × 50	
M12	M 12 × 60 (GV)	23,0
	M 12 × 60 (A4)	25,0
	M 12 × 70	30,0
M16	M 16 × 70	25,0
	M 16 × 80	
	M 16 × 100 (A4)	
	M 16 × 100 (GV)	
	M 16 × 120	
M20	M 20 × 100	40,0
	M 20 × 120	
M24	M 24 × 120	50,0
M30	M 30 × 150	70,0

⑥ für folgende Typen:
 995-G (GV, A4)
 1036-G (GV, A4)

Gewindegröße / Ankerabmessung		a [mm]
M8	M 8 × 50	30,0
M10	M 10 × 60	35,0
M12	M 12 × 45	18,0
	M 12 × 70	40,0
M16	M 16 × 60	24,0
	M 16 × 100	32,0
M20	M 20 × 70	30,0
	M 20 × 100	40,0
M24	M 24 × 80	24,0

⑦ für folgende Typen:
 1130 (GV)
 1140 (GV, A4)

Gewindegröße / Ankerabmessung		a [mm]
M12	M 12 × 60	22,0
M16	M 16 × 75	22,0
	M 16 × 100	35,0
M20	M 20 × 90	25,0
	M 20 × 120	45,0
M24	M 24 × 100	30,0
M30	M 30 × 135	35,0

⑧ für Typ 995-DG (GV)

English

Deutsch

Français

Español

Nederlands

Polski

Types de douilles

Ces instructions d'utilisation sont valables pour les douilles de fixation DEMU figurant ci-dessous :

T-FIXX®
(GV, A4)



Douilles à barre d'ancrage

Types 4010 (GV, FV), 4030 (GV, FV), 3016 (GV), 3010 (A4-80), 1980-S (GV), 1988-S (GV), 1554 (GV, FV, A4-80), 1558 (GV, FV, A4-80)



Douilles à pied d'ancrage

Types 1988 (GV, FV, A4-50, A4-80), 1985 (GV), 1980-P (GV, FV, A4-80)



Douilles de fixation

Types 995-GB (GV), 995 (A4), 995-G (GV, A4), 995-DG (GV), 1036-G (GV, A4), 1130 (GV), 1140 (GV, A4)



Informations générales pour l'utilisation

Afin de garantir la meilleure adhérence possible entre la douille de fixation et le béton, assurez vous que la surface de la douille soit propre et exempte de poussière ou d'huile.

Le béton doit être coulé avec précaution, éviter le contact direct entre les douilles de fixation et les outils de compactage. Nous recommandons une sécurité supplémentaire en liaisonnant solidement les douilles au coffrage.

La douille de fixation peut être facilement noyée dans le béton. Nous recommandons fortement l'utilisation de plaques de fixations ou l'un des accessoires de la page 15. Les fixations des douilles doivent être retirées rapidement après le décoffrage.

Le filetage intérieur de la douille doit être séché et à nouveau protégé avec un bouchon contre les agressions possibles telles que l'eau, la poussière et l'huile. Aussi après l'assemblage final il faut assurer que l'intérieur de la douille reste sec.

Le boulon ou la vis (pas métrique standard) pour la fixation de l'élément doit être choisi en fonction des calculs et des spécifications du bureau d'ingénierie. Les profondeurs minimales / maximales de vissage pour les boulons et le couple de serrage (T_{inst}) figurent en pages 18-19.

La douille de fixation ne doit pas être soumise à sa capacité de charge complète avant que le béton n'ait atteint sa résistance finale.

Soudure

Tous les produits DEMU dans notre catalogue technique «Douilles de fixation DEMU» peuvent être soudés par points. Toutefois, toute soudure, notamment les soudures de positionnement, peuvent influencer négativement les propriétés mécaniques des douilles. Souder peut affecter les performances d'un produit.

Si pour votre utilisation il est impossible d'éviter toute soudure, il faut tenir compte des éléments suivants :

- une possible modification des performances et une possible réduction des capacités de charge
- enlever le revêtement de protection (galva...) avant de commencer à souder et assurez vous que les fumées de soudures sont correctement évacuées pendant la soudure.
- utiliser les équipements de protection appropriés le client doit s'assurer que la soudure est conforme aux recommandations réglementaires sur les soudures.

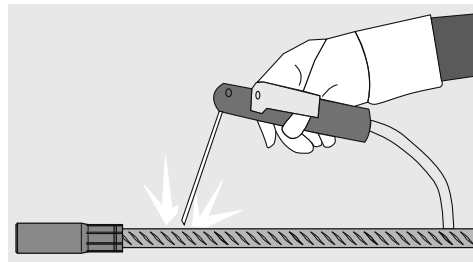

HALFEN ne pourrait être tenu responsable pour tout dommage causé à ou par des douilles DEMU qui ont été soudées.

Utilisation des accessoires

Fixation plastique

Type 2275 (h=2 mm)



Type 2280 (h=10 mm)



Téton de fixation

Type 2250



Bouchon plastique

Type 2244



Réducteur de fixation

Type 2600



Diamètres des filetages disponibles : M8 – M30

d_{nom}	M8*	M10	M12	M16	M20	M24	M30*
-----------	-----	-----	-----	-----	-----	-----	------

* seul le type 2280 est disponible

Figure 1

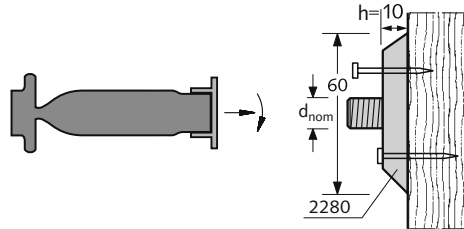

Diamètres des filetages disponibles : M6 – M24

d_{nom}	M6	M8	M10	M12	M16	M20	M24
\varnothing trou de perçage [mm]	11	11	11	11	17	17	17

Figure 2

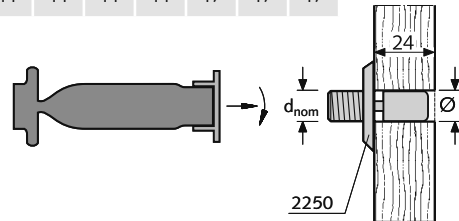

Diamètres des filetages disponibles : M6 – M42

d_{nom}	M6	M8	M10	M12	M16	M20	M24	M30	M36	M42
-----------	----	----	-----	-----	-----	-----	-----	-----	-----	-----

Figure 3

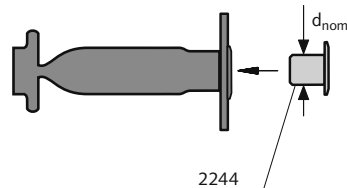

Diamètres des filetages disponibles : M12 – M42

d_{nom}	M12	M16	M20	M24	M30	M36	M42
d_B diamètre de la vis	M6	M8	M8	M10	M10	M10	M12

Figure 4

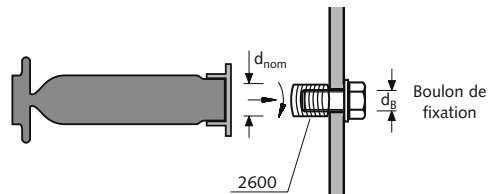

English

Deutsch

Français

Español

Nederlands

Polski

Étapes de la mise en place (exemple avec T-FIXX; fixation des autres douilles de façon identique)

Fixation au coffrage

Démontage pour le préparation de l'assemblage final

Vissage et fixation de la vis ①

Cas A
avec fixation en plastique à clouer

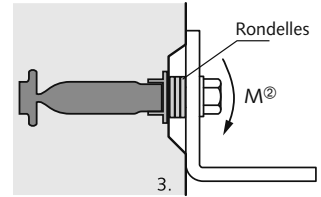
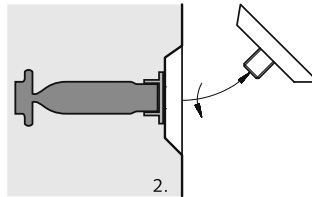
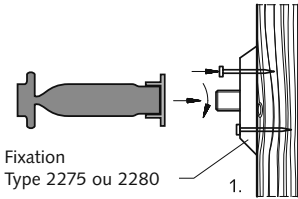

Mise en place de la fixation voir page 15, figure 1

Enlever le coffrage, dévisser la fixation en plastique

Cas B
avec téton de fixation cassable

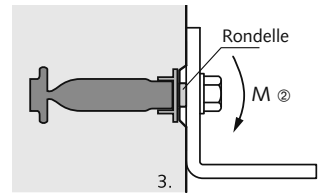
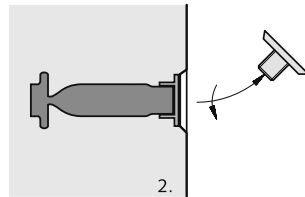
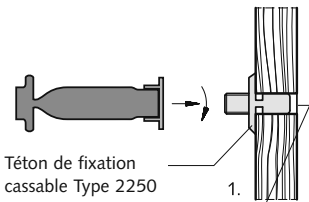

Trou percé dans le coffrage: voir page 15, figure 2

Enlever le coffrage, dévisser le reste du téton

Cas C
Douille de fixation avec collerette de fixation

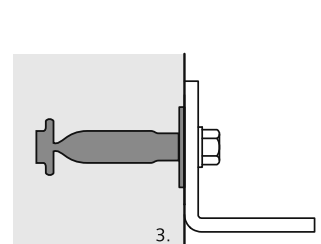
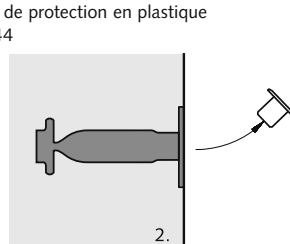
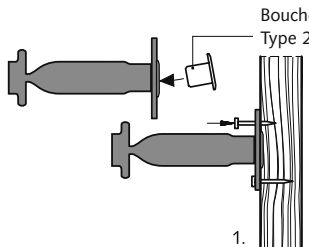

Fixation du bouchon d'étanchéité voir page 15, figure 3

Enlever le coffrage, enlever le bouchon d'étanchéité

① Couple de serrage T_{inst} → voir tableau en page 18

② La flexion de la vis doit être vérifiée par le client ! (La vis de fixation ne fait partie des fournitures des douilles de fixation)

Étapes de la mise en place (exemple avec T-FIXX; fixation des autres douilles de façon identique)

Fixation au coffrage

Démontage pour la préparation de l'assemblage final

Vissage et fixation de la vis ①

Cas D
avec une vis à tête hexagonale

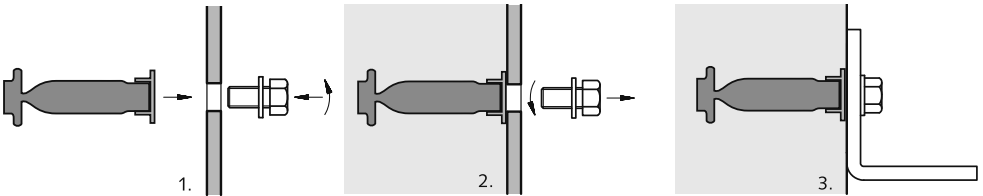

Dévisser la vis à tête hexagonale, enlever le coffrage

Cas E
avec réducteur de filetage et vis à tête hexagonale

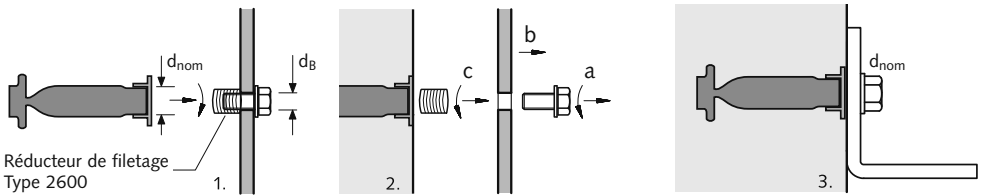

Mise en place de l'adaptateur: voir page 15, figure 4

a) dévisser la vis à tête hexagonale,
b) enlever le coffrage,
c) dévisser le réducteur

Cas F
avec fixation magnétique sur coffrage en acier

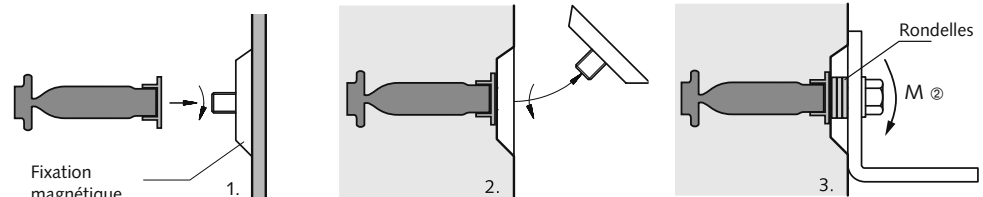

Enlever le coffrage, dévisser la fixation magnétique

① Couple de serrage T_{inst} → voir tableau en page 18

② La flexion de la vis doit être vérifiée par le client ! (La vis de fixation ne fait partie des fournitures des douilles de fixation)

Couple de serrage T_{inst} [Nm]*

Filetage	T-FIXX®	Douille à barre d'ancrage / Douille à vis d'ancrage	Douille de fixation
M10	≤ 8	-	≤ 4
M12	≤ 10	≤ 10	≤ 8
M16	≤ 30	≤ 30	≤ 17
M20	≤ 60	≤ 50	≤ 25
M24	-	≤ 90	≤ 53
M30	-	≤ 180	≤ 96
M36	-	≤ 250	-
M42	-	≤ 300	-

* Les couples de serrage sont uniquement valables pour des boulons non lubrifiés.

Détermination de la longueur de la vis

Généralités

Les éléments de fixation sont liés à la douille de fixation par l'intermédiaire d'une vis à filetage métrique standard et de rondelles ou d'une tige filetée, d'une rondelle et d'un écrou. Les éléments de fixation ne font pas partie du système de fixation DEMU et doivent être commandés séparément. L'élément de fixation (la vis) doit être choisie suivant les recommandations du bureau d'ingénierie.

Profondeur de vissage de la vis

Pour toutes les douilles de fixations, il y a une profondeur de vissage minimale et maximale. Les valeurs minimales sont données dans le tableau ci-dessous. Les valeurs maximales correspondantes pour chaque modèle sont données dans les tableaux de la page suivante. Pour trouver la longueur de la vis recommandée, procédez comme expliqué ci-dessous.

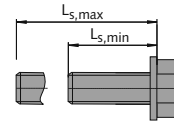

Détermination de la longueur de la vis (L_s)

Longueur de la vis (L_s)
 $L_{s,min} = s + k$ (profondeur à visser minimale)
 $L_{s,max} = a + k$ (profondeur à visser maximale)

- k = Épaisseur à pincer (épaisseur de l'élément fixé et des rondelles)
- s = profondeur à visser minimale (→ voir tableau ci-dessous)
- a = profondeur à visser maximale (→ voir tableau en page 19)

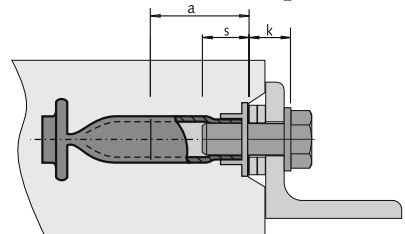

Profondeurs de vissage minimales s [mm]

Filetage	T-FIXX®	Douille de fixation 1988	Douille de fixation 1985/1980-P / Douille à barre d'ancrage / Douille à vis d'ancrage ①,②
M6	-	-	7,2
M8	-	-	9,6
M10	17,0	-	12,0 / 15,0
M12	20,0	16,4	14,4 / 18,0
M16	26,0	21,2	19,2 / 24,0
M20	32,0	26,0	24,0 / 30,0
M24	-	30,8	28,8 / 36,0
M30	-	38,0	36,0
M36	-	45,2	43,2
M42	-	52,4	50,4

① $s = 1,2 \times d_{nom}$

② Des valeurs plus importantes ($s = 1,5 \times d_{nom}$) s'appliquent pour des douilles avec une collerette de fixation → types 1985 (GV), 1036-G (GV, A4) et 1130 (GV).

**Profondeur maximale de vissage a [mm]
pour T-FIXX® ①**

Filetage / type de douille		a [mm]
M10	Toutes dimensions	32,0
M12	M 12 × 50	30,0
	M 12 × 70	28,0
	M 12 × 95	
	M 12 × 115	
M16	M 16 × 60	32,0
	M 16 × 80	50,0
	M 16 × 100	
	M 16 × 110	
	M 16 × 125	
M20	M 20 × 70	44,0
	M 20 × 100	62,0
	M 20 × 125	
	M 20 × 145	

① pour douille type T-FIXX® (GV, A4)

**Profondeur maximale de vissage a [mm]
pour douilles à vis / à barre d'ancrage ② et ③**

Filetage	a [mm]
M12	23,0
M16	29,0
M20	35,0
M24	46,0
M30	60,0
M36	74,0
M42	68,0

② pour les types de douilles suivants:

- 1985 (GV)
- 1980-P (GV, FV, A4-80)
- 3016 (GV)
- 3010 (A4-80)
- 1980-S (GV)
- 1988-S (GV)
- 1554 (GV, FV, A4-80)
- 1558 (GV, FV, A4-80)

Filetage	4010/4030	1988*
	a [mm]	a [mm]
M12	-	25,0
M16	25,0	31,0
M20	33,0	37,0
M24	38,0	48,0
M30	48,0	62,0
M36	-	76,0
M42	65,0	70,0

③ pour les types de douilles suivants:

- 1988 (GV, FV, A4-50, A4-80)
- 4010 (GV, FV)
- 4030 (GV, FV)

* Pour les douilles à vis d'ancrage avec une couche d'étanchéité en dessous du manchon, les valeurs doivent être réduites de 3,0 mm.

**Profondeur maximale de vissage a [mm]
pour les douilles de fixation ④ - ⑧**

Filetage / type de douille		a [mm]
M6	M 6 × 30	14,0
	M 6 × 40	20,0
M8	M 8 × 40	18,0
	M 8 × 50	25,0

④ pour douille type 995-GB (GV)

Filetage / type de douille		a [mm]
M6	M 6 × 40	25,0

⑤ pour douille type 995 (A4)

Filetage / type de douille		a [mm]
M8	M 8 × 50	20,0
M10	M 10 × 50	
M12	M 12 × 60 (GV)	23,0
	M 12 × 60 (A4)	25,0
	M 12 × 70	30,0
M16	M 16 × 70	25,0
	M 16 × 80	
	M 16 × 100 (A4)	32,0
	M 16 × 100 (GV)	
M20	M 20 × 100	40,0
	M 20 × 120	
M24	M 24 × 120	50,0
M30	M 30 × 150	70,0

⑥ pour les types de douilles suivants:

- 995-G (GV, A4)
- 1036-G (GV, A4)

Filetage / type de douille		a [mm]
M8	M 8 × 50	30,0
M10	M 10 × 60	35,0
M12	M 12 × 45	18,0
	M 12 × 70	40,0
M16	M 16 × 60	24,0
	M 16 × 100	32,0
M20	M 20 × 70	30,0
	M 20 × 100	40,0
M24	M 24 × 80	24,0

⑦ pour les types de douilles suivants:

- 1130 (GV)
- 1140 (GV, A4)

Filetage / type de douille		a [mm]
M12	M 12 × 60	22,0
M16	M 16 × 75	22,0
	M 16 × 100	35,0
M20	M 20 × 90	25,0
	M 20 × 120	45,0
M24	M 24 × 100	30,0
M30	M 30 × 135	35,0

⑧ pour douille type 995-DG (GV)

English

Deutsch

Français

Español

Nederlands

Polski

Tipo de fijaciones

Estas instrucciones de montaje son válidas para los siguientes modelos de Casquillos DEMU:

T-FIX®
(GV, A4)



Casquillo de fijación tipo barra

modelo 4010 (GV, FV), 4030 (GV, FV), 3016 (GV),
3010 (A4-80), 1980-S (GV), 1988-S (GV),
1554 (GV, FV, A4-80), 1558 (GV, FV, A4-80)



Casquillo de fijación tipo tornillo

modelo 1988 (GV, FV, A4-50, A4-80), 1985 (GV),
1980-P (GV, FV, A4-80)



Modelo 1988
Modelo 1985

Casquillo de fijación con agujero

modelo 995-GB (GV), 995 (A4), 995-G (GV, A4),
995-DG (GV), 1036-G (GV, A4), 1130 (GV), 1140 (GV, A4)



Notas generales para la instalación

Para garantizar la mejor unión posible entre el anclaje de fijación y el hormigón, asegúrese de que la superficie del anclaje esté libre de suciedad, aceite, etc.

El hormigón tiene que ser vertido con cuidado; evite el contacto directo entre el vibrador y el casquillo de fijación. Se recomienda asegurar adicionalmente los anclajes mediante atado de cables.

Los casquillos de fijación se pueden instalar al ras o rehundidos. Para los anclajes rehundidos se debe usar un plato de fijación.

Rápidamente después de quitar el encofrado debería de retirar los platos de fijación. **El interior de la rosca debe estar seco y además protegido contra la entrada de agua,**

polvo o grasa hasta que vaya a ser usado ej. por elementos de fijación. Puede utilizar unos tapones. Asegúrese de que el interior del casquillo permanezca seco después del ensamblaje final.

El elemento de fijación (perno / tornillo con rosca métrica estándar) debe seleccionarse de acuerdo con las especificaciones del ingeniero. La longitud de atornillado mínima / máxima para los pernos y el par de apriete (T_{inst}) se encuentran en las páginas 24 - 25.

El anclaje de fijación no debe estar sujeto a la capacidad de carga completa hasta que el hormigón haya alcanzado su resistencia final.

Soldadura

Todos los productos DEMU (hechos de acero) enumerados en el catálogo „DEMU FIX“ son básicamente soldables. Sin embargo, cualquier forma de soldadura, incluida la soldadura por puntos, puede afectar las propiedades mecánicas de los productos DEMU.

Si la soldadura en la aplicación es inevitable, tenga en cuenta lo siguiente:

- un posible cambio en el rendimiento; una posible reducción en la capacidad de carga
- elimine cualquier capa de recubrimiento antes de soldar, y asegúrese de que los humos de soldadura se extraigan con seguridad durante la soldadura
- usar equipo de protección obligatorio
- el cliente es responsable de asegurarse de que se respeten las normas de soldadura aplicables

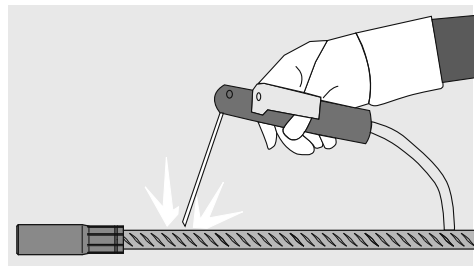

HALFEN no asume ninguna responsabilidad por daños causados por productos DEMU o productos DEMU que hayan sido soldados.

Accesorios de montaje

Plato para clavar

Tipo 2275 (h=2 mm)



Tipo 2280 (h= 10 mm)



Pin para fijación

Tipo 2250



Tapón de sellado

Tipo 2244



Adaptador de rosca

Tipo 2600



Métricas disponibles: M8 – M30

d_{nom}	M8*	M10	M12	M16	M20	M24	M30*
-----------	-----	-----	-----	-----	-----	-----	------

* Solamente disponible para tipo 2280

Figura 1

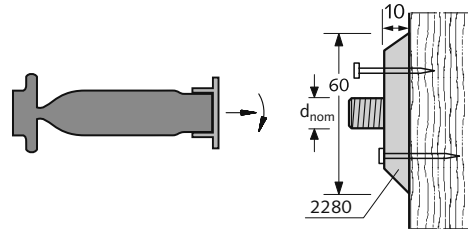

Métricas disponibles: M6 – M24

d_{nom}	M6	M8	M10	M12	M16	M20	M24
\varnothing agujero perforación [mm]	11	11	11	11	17	17	17

Figura 2

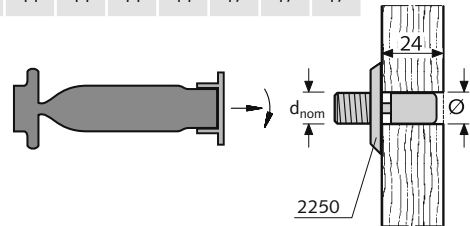

Métricas disponibles: M6 – M42

d_{nom}	M6	M8	M10	M12	M16	M20	M24	M30	M36	M42
-----------	----	----	-----	-----	-----	-----	-----	-----	-----	-----

Figura 3

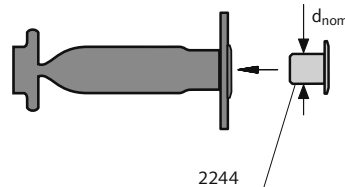

Métricas disponibles: M12 – M42

d_{nom}	M12	M16	M20	M24	M30	M36	M42
d_B tornillo para fijación	M6	M8	M8	M10	M10	M10	M12

Figura 4

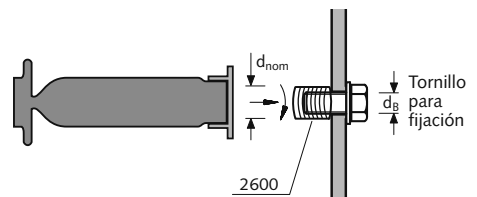

Pasos para montaje (Ver: T-FIXX; fijación con otros tipos similares)

English

Deutsch

Français

Español

Nederlands

Polski

Fijación al encofrado

Preparación para montaje

Atornillar y fijar el tornillo ①

Caso A
con plato de plástico

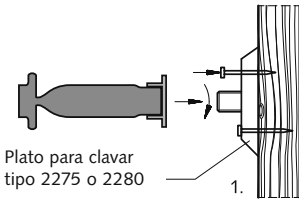

Plato para clavar tipo 2275 o 2280

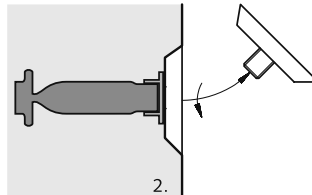

Retirar el encofrado, desenroscar el plato

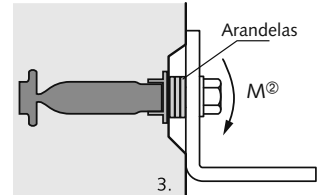

Montaje del plato: ver pag. 21, figura 1

Caso B
con Pin de fijación

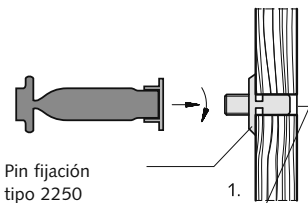

Pin fijación tipo 2250

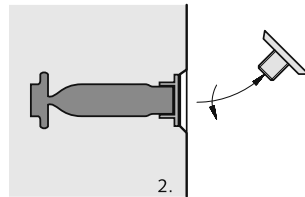

Retirar el encofrado, desenroscar el resto del pin

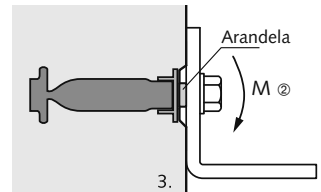

Taladro en el encofrado: ver pág. 21, figura 2

Caso C
Casquillos de fijación con corona, para fijación, integrada

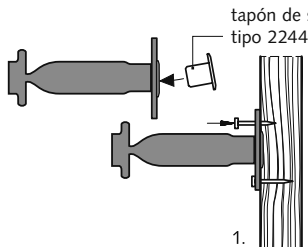

Insertar el tapón: ver pag. 21, figura 3

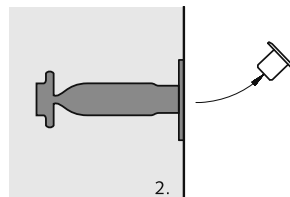

Retirar el encofrado, retirar el tapón

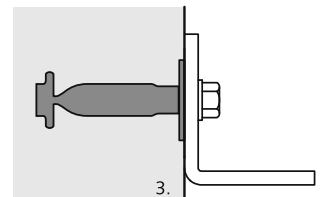

① Par de Apriete T_{inst} → ver tabla pag. 25

② El Momento transmitido al tornillo debe ser verificado por el cliente (tornillos no incluidos)

Pasos para montaje (Ver: T-FIXX; fijación con otros tipos similares)

Fijación al encofrado

Preparación para montaje

Atornillar y fijar el tornillo ①

Caso D
con tornillo hexagonal

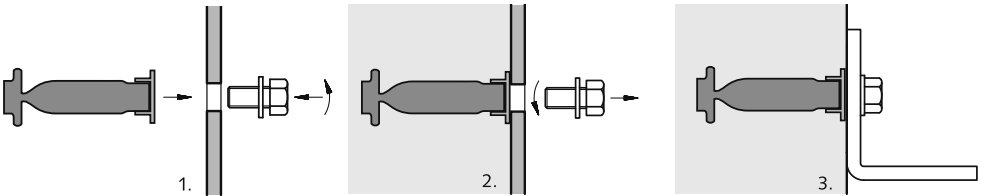

Desenroscar el tornillo hexagonal,
retirar el encofrado

Caso E
con adaptador de rosca y tornillo hexagonal

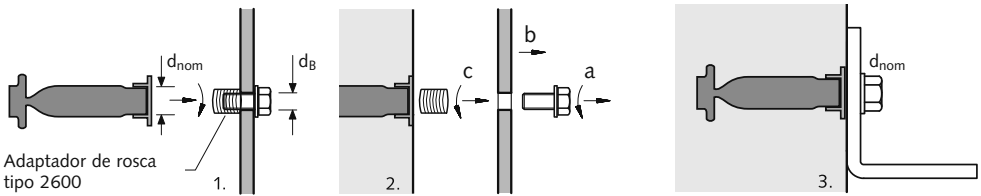

Adaptador de rosca
tipo 2600

a) Desenroscar el tornillo hexagonal,
b) retirar el encofrado,
c) retirar el adaptador

Montaje del adaptador:
ver pág. 21, figura 4

Caso F
con plato magnético para encofrado metálico

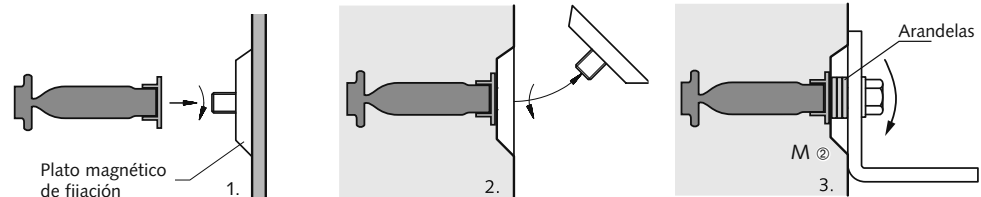

Plato magnético
de fijación

Retirar el encofrado,
desenroscar el plato magnético

① Par de Apriete T_{inst} → ver tabla pag. 25

② El Momento transmitido al tornillo debe ser verificado por el cliente (tornillos no incluidos)

Par de apriete T_{inst} [Nm]*

Métrica	T-FIXX®	Perno anclaje / Barra anclaje	Casquillo de anclaje
M10	≤ 8	-	≤ 4
M12	≤ 10	≤ 10	≤ 8
M16	≤ 30	≤ 30	≤ 17
M20	≤ 60	≤ 50	≤ 25
M24	-	≤ 90	≤ 53
M30	-	≤ 180	≤ 96
M36	-	≤ 250	-
M42	-	≤ 300	-

* Los pares de apriete se aplican solo a los pernos que no tienen lubricación.

Determinar la longitud del tornillo

General

La pieza de instalación se sujeta con un tornillo de métrica estándar y arandela o con una varilla. Los componentes de sujeción mencionados no están incluidos en el DEMU, deben pedirse por separado. Los tornillos utilizados deben estar acorde con lo indicado por el ingeniero responsable.

Longitud de rosca del tornillo

Para todos los casquillos de fijación hay un máximo y un mínimo de longitud de rosca. Tenga en cuenta las longitudes de los tornillos. Las longitudes mínimas de roscado se resumen en la siguiente tabla. Los valores máximos correspondientes se pueden encontrar en las tablas en la siguiente página. Para encontrar la longitud de perno requerida, proceda como se describe a continuación.

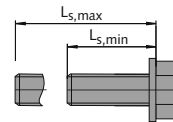

Determinación de la longitud de perno requerida (L_s)

Longitud de tornillo (L_s)

- $L_{s,min}$ = $s + k$ (longitud mínima de tornillo)
- $L_{s,max}$ = $a + k$ (longitud máxima de tornillo)

- k = espesor a fijar (espesor del angular metálico y espesor de las arandelas de fijación)
- s = longitud mínima roscada (→ ver tabla de abajo)
- a = longitud máxima roscada (→ ver tabla en página 25)

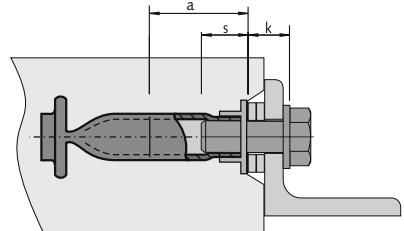

Longitud mínima roscada s [mm]

Métrica	T-FIXX®	Anclaje DEMU 1988	Anclaje DEMU1985/1980-P / Barra de anclaje / Casquillo de anclaje ①,②
M6	-	-	7,2
M8	-	-	9,6
M10	17,0	-	12,0 / 15,0
M12	20,0	16,4	14,4 / 18,0
M16	26,0	21,2	19,2 / 24,0
M20	32,0	26,0	24,0 / 30,0
M24	-	30,8	28,8 / 36,0
M30	-	38,0	36,0
M36	-	45,2	43,2
M42	-	52,4	50,4

① valor $s = 1,2 \times d_{nom}$

② valores más altos ($s = 1,5 \times d_{nom}$) se aplican para fijar anclajes con placa de clavado integrada → tipos 1985 (GV), 1036-G (GV, A4) y 1130 (GV).

Longitud Máxima de rosca a [mm] para T-FIXX® ①

Métrica / tipo de casquillo		a [mm]
M10	all types	32,0
M12	M 12 × 50	30,0
	M 12 × 70	28,0
	M 12 × 95	
	M 12 × 115	
M16	M 16 × 60	32,0
	M 16 × 80	50,0
	M 16 × 100	
	M 16 × 110	
	M 16 × 125	
M20	M 20 × 70	44,0
	M 20 × 100	62,0
	M 20 × 125	
	M 20 × 145	

① para el tipo T-FIXX® (GV, A4)

Longitud máxima de rosca a [mm] para casquillo de fijación / barras de fijación ②, ③

Métrica	a [mm]
M12	23,0
M16	29,0
M20	35,0
M24	46,0
M30	60,0
M36	74,0
M42	68,0

② para los siguientes tipos:

- 1985 (GV)
- 1980-P (GV, FV, A4-80)
- 3016 (GV)
- 3010 (A4-80)
- 1980-S (GV)
- 1988-S (GV)
- 1554 (GV, FV, A4-80)
- 1558 (GV, FV, A4-80)

Métrica	4010/4030	1988*
	a [mm]	a [mm]
M12	-	25,0
M16	25,0	31,0
M20	33,0	37,0
M24	38,0	48,0
M30	48,0	62,0
M36	-	76,0
M42	65,0	70,0

③ para los siguientes tipos:

- 1988 (GV, FV, A4-50, A4-80)
- 4010 (GV, FV)
- 4030 (GV, FV)

* para anclajes de pernos con sellado especial en la parte inferior del manguito (tipos A4-50, A4-80), los valores deben reducirse en 3,0 mm.

Longitud máxima de rosca a [mm] para los casquillos de fijación ④-⑧

Métrica / tipo de casquillo		a [mm]
M6	M 6 × 30	14,0
	M 6 × 40	20,0
M8	M 8 × 40	18,0
	M 8 × 50	25,0

④ para el tipo 995-GB (GV)

Métrica / tipo de casquillo		a [mm]
M6	M 6 × 40	25,0

⑤ para el tipo 995 (A4)

Métrica / tipo de casquillo		a [mm]
M8	M 8 × 50	20,0
M10	M 10 × 50	
M12	M 12 × 60 (GV)	23,0
	M 12 × 60 (A4)	25,0
	M 12 × 70	30,0
M16	M 16 × 70	25,0
	M 16 × 80	
	M 16 × 100 (A4)	32,0
	M 16 × 100 (GV)	
M20	M 20 × 100	40,0
	M 20 × 120	
M24	M 24 × 120	50,0
M30	M 30 × 150	70,0

⑥ para los siguientes tipos:

- 995-G (GV, A4)
- 1036-G (GV, A4)

Métrica / tipo de casquillo		a [mm]
M8	M 8 × 50	30,0
M10	M 10 × 60	35,0
M12	M 12 × 45	18,0
	M 12 × 70	40,0
M16	M 16 × 60	24,0
	M 16 × 100	32,0
M20	M 20 × 70	30,0
	M 20 × 100	40,0
M24	M 24 × 80	24,0

⑦ para los siguientes tipos:

- 1130 (GV)
- 1140 (GV, A4)

Métrica / tipo de casquillo		a [mm]
M12	M 12 × 60	22,0
M16	M 16 × 75	22,0
	M 16 × 100	35,0
M20	M 20 × 90	25,0
	M 20 × 120	45,0
M24	M 24 × 100	30,0
M30	M 30 × 135	35,0

⑧ para el tipo 995-DG (GV)

Anker types

Deze montagehandleiding geldt voor de volgende DEMU bevestigingsankers:

T-FIXX®
(GV, A4)



Stekanker, staafanker

types 4010 (GV, FV), 4030 (GV, FV), 3016 (GV), 3010 (A4-80), 1980-S (GV), 1988-S (GV), 1554 (GV, FV, A4-80), 1558 (GV, FV, A4-80)



Boutanker

types 1988 (GV, FV, A4-50, A4-80), 1985 (GV), 1980-P (GV, FV, A4-80)



Betonschroefhuls

types 995-GB (GV), 995 (A4), 995-G (GV, A4), 995-DG (GV), 1036-G (GV, A4), 1130 (GV), 1140 (GV, A4)



Algemene inbouw-instructies

Zorg ervoor dat het oppervlak van het anker vrij is van vuil, olie, etc. om de optimale binding tussen bevestigingsanker en beton te garanderen.

Het beton moet zorgvuldig worden gestort; vermijd direct contact tussen verdichtingsapparatuur en bevestigingsanker. Extra vastzetten van de ankers aan de wapening wordt aanbevolen.

Bevestigingsankers kunnen gelijk met het oppervlak of verdiept worden ingebouwd. Bij verdiept ingebouwde ankers moeten sluitringen worden gebruikt ter ondersteuning.

Direct na het ontkisten dienen de spijkerplaten te worden verwijderd. **De binnenzijde van de draadbus dient na het ontkisten verder te worden beschermd tegen indringen**

van water, vuil of olie tot het moment van bevestigen.

Ook na de montage dient de binnenzijde van de draadbus te worden beschermd tegen indringen van water.

De bevestigingsbout moet worden gekozen op basis van de statische specificaties van de constructeur.

Minimale/maximale indraailengte(s) voor bevestigingsbouten en maximale aandraaimoment (T_{inst}) zijn te vinden in de tabellen op pag. 30 - 31.

Het bevestigingsanker mag niet op zijn volledige capaciteit worden belast voordat het beton de vereiste sterkte bereikt heeft.

Lassen

Alle stalen producten in de technische documentatie (DEMU FIX) zijn lasbaar. Echter kan lassen, ook hechtlassen, de mechanische eigenschappen van de DEMU-producten negatief beïnvloeden.

Indien lassen in de toepassing onvermijdelijk is, dient rekening te worden gehouden met het volgende:

- een mogelijke reductie van belastbaarheid en wijziging van gebruikseigenschappen.
- verwijder de eventueel aanwezige coatinglaag voor het lassen en zorg ervoor dat lasdampen veilig worden afgezogen.
- gebruik voorgeschreven beschermingsmiddelen.
- de klant is verantwoordelijk voor naleving van de geldende lasvoorschriften.

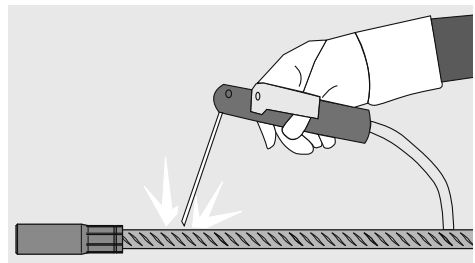

HALFEN is niet aansprakelijk voor eventuele schade ontstaan aan of door DEMU-producten waaraan gelast is.

Montage van accessoires

Flensplaat

type 2275 (h=2 mm)



type 2280 (h=10 mm)



Breekpen

type 2250



Afsluitdop

type 2244



Montagenippel

type 2600



Beschikbare diameter schroefdraad: M8 - M30

d _{nom}	M8*	M10	M12	M16	M20	M24	M30*
------------------	-----	-----	-----	-----	-----	-----	------

* alleen type 2280 beschikbaar

Afbeelding 1

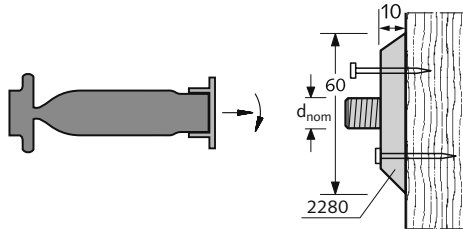

Beschikbare diameter schroefdraad: M6 - M24

d _{nom}	M6	M8	M10	M12	M16	M20	M24
∅ boorgat [mm]	11	11	11	11	17	17	17

Afbeelding 2

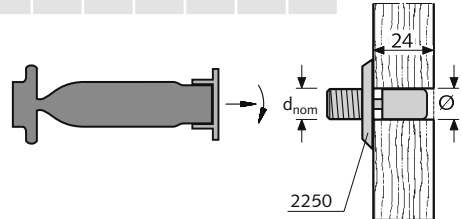

Beschikbare diameter schroefdraad: M6 - M42

d _{nom}	M6	M8	M10	M12	M16	M20	M24	M30	M36	M42
------------------	----	----	-----	-----	-----	-----	-----	-----	-----	-----

Afbeelding 3

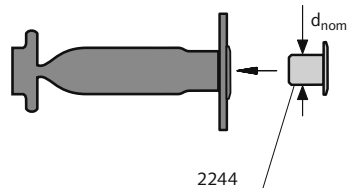

Beschikbare diameter schroefdraad: M12 - M42

d _{nom}	M12	M16	M20	M24	M30	M36	M42
d _B bevestigingsbout	M6	M8	M8	M10	M10	M10	M12

Afbeelding 4

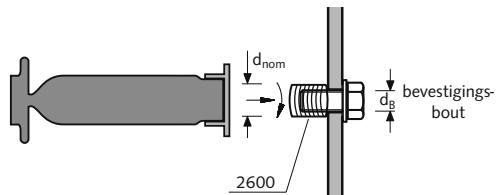

English

Deutsch

Français

Español

Nederlands

Polski

Montage in stappen (T-FIXX afgebeeld; bevestiging van de andere bevestigingsankers analoog)

English

Bevestiging aan de bekisting

Vorbereiding voor montage

Montage van de bout ①

**Voorbeeld A
met kunststof flensplaat**

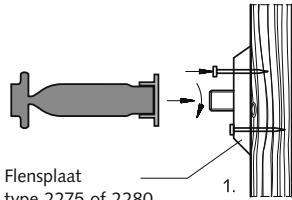

Flensplaat
type 2275 of 2280

Montage van flensplaat:
zie pag. 27, afbeelding 1

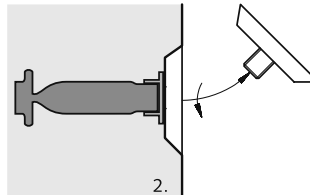

Bekisting verwijderen,
flensplaat losdraaien

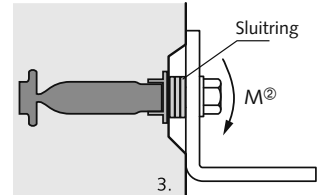

Deutsch

Français

Español

Nederlands

Polski

**Voorbeeld B
met kunststof breekpen**

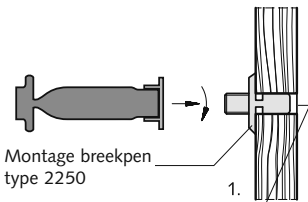

Montage breekpen
type 2250

Boorgat in bekisting:
zie pag. 27, afbeelding 2

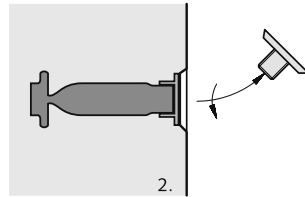

Bekisting verwijderen,
restant van breekpen losdraaien

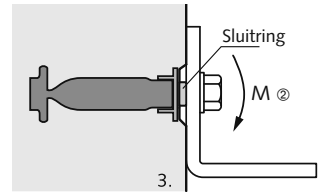

**Voorbeeld C
Bevestigingsanker met flensplaat**

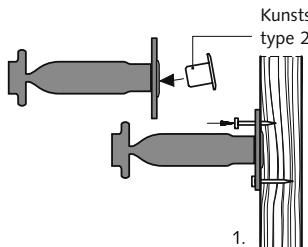

Kunststof afsluitdop
type 2244

Bevestiging van afsluitdop:
zie pag. 27, afbeelding 3

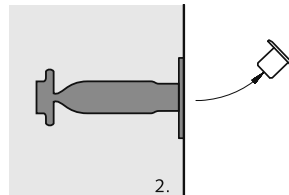

Bekisting verwijderen,
afsluitdop verwijderen

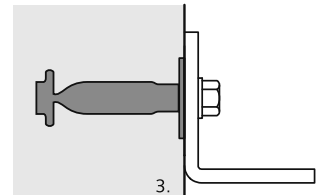

① Moment T_{inst} → zie tabel op pag. 30

② Buiging van de bout moet door de klant worden gecontroleerd (bout is niet bij de levering inbegrepen)

Montage in stappen (T-FIXX afgebeeld; bevestiging van de andere bevestigingsankers analoog)

Bevestiging aan de bekisting

Vorbereiding voor montage

Montage van de bout ①

Voorbeeld D met zeskantbout

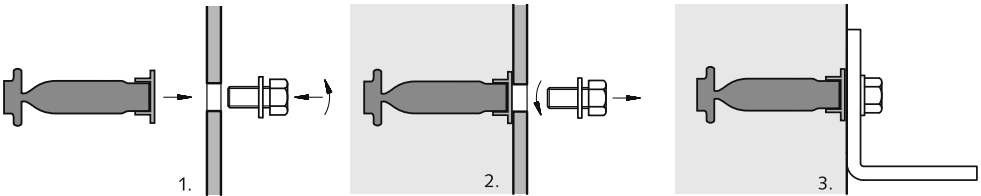

Zeskantbout losdraaien, bekisting verwijderen

Voorbeeld E met montagenippel en zeskantbout

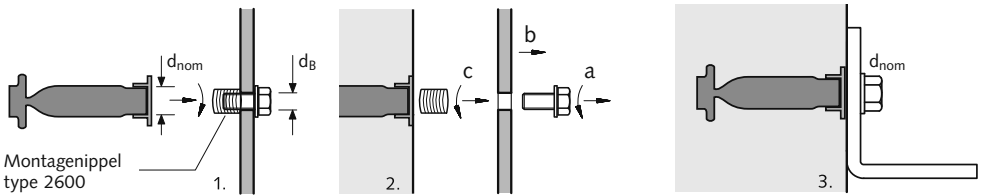

Montagenippel type 2600

a) Zeskantbout losdraaien,
b) bekisting verwijderen,
c) montagenippel losdraaien

Montage van montagenippel: zie pag. 27, afbeelding 4

Voorbeeld F met magnetische flensplaat aan stalen bekisting

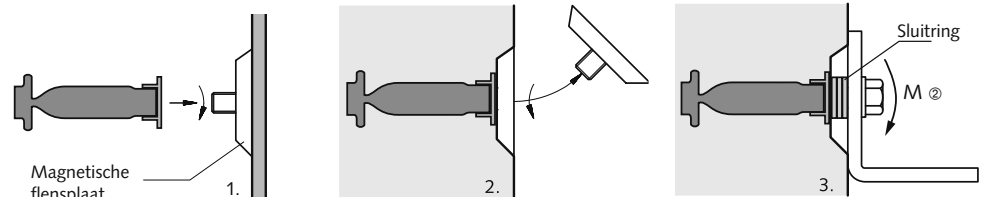

Magnetische flensplaat

Bekisting verwijderen, magnetische flensplaat losdraaien

① Moment T_{inst} → zie tabel op pag. 30

② Buiging van de bout moet door de klant worden gecontroleerd (bout is niet bij de levering inbegrepen)

Aandraaimoment T_{inst} [Nm]*

Draaddiameter	T-FIXX®	Boutanker / Stekanker	Schroefhuls
M10	≤ 8	-	≤ 4
M12	≤ 10	≤ 10	≤ 8
M16	≤ 30	≤ 30	≤ 17
M20	≤ 60	≤ 50	≤ 25
M24	-	≤ 90	≤ 53
M30	-	≤ 180	≤ 96
M36	-	≤ 250	-
M42	-	≤ 300	-

* De aandraaimomenten gelden alleen voor bouten die niet voorzien zijn van vet.

Het bepalen van de boutlengte

Algemene informatie

De te bevestigen constructie is aan het ingebouwde anker bevestigd met een bevestigingsbout met standaard metrische draad en sluitring of met een draadstang, sluitring en moer. De bevestigingsonderdelen zijn niet bij de DEMU bevestigingssystemen inbegrepen en dienen separaat te worden besteld. Het bevestigingsmiddel (bout) moet worden gekozen op basis van de statische specificaties van de constructeur.

Indraailengte van de bout

Voor alle bevestigingsmiddelen geldt een minimale en een maximale indraailengte. De minimale waarden zijn te vinden in onderstaande tabel. De bijbehorende maximale waarden voor elk type zijn te vinden in de tabellen op de volgende pagina. Voor het bepalen van de gewenste boutlengte zie toelichting hieronder.

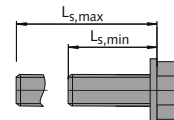

Het bepalen van de vereiste boutlengte (L_s)

Boutlengte (L_s)

- $L_{s,min}$ = $s + k$ (minimale boutlengte)
- $L_{s,max}$ = $a + k$ (maximale boutlengte)

- k = klemdikte (dikte van de hoekstaal en de sluitringen)
- s = minimale indraailengte (→ zie tabel onder)
- a = maximale indraailengte (→ zie tabellen op pag. 31)

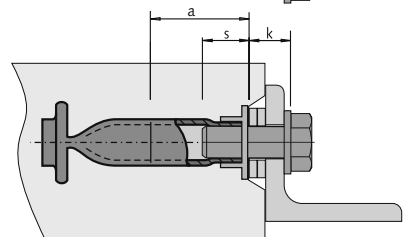

Minimale indraailengte s [mm]

Draaddiameter	T-FIXX®	Boutanker 1988	Boutanker 1985/1980-P / Stekanker / Schroefhuls ①,②
M6	-	-	7,2
M8	-	-	9,6
M10	17,0	-	12,0 / 15,0
M12	20,0	16,4	14,4 / 18,0
M16	26,0	21,2	19,2 / 24,0
M20	32,0	26,0	24,0 / 30,0
M24	-	30,8	28,8 / 36,0
M30	-	38,0	36,0
M36	-	45,2	43,2
M42	-	52,4	50,4

① $s = 1,2 \times d_{nom}$

② voor de bevestigingsankers met flensplaat gelden hogere waarden ($s = 1,5 \times d_{nom}$) → bevestigingsankers types 1985 (GV), 1036-G (GV, A4) en 1130 (GV).

Maximale indraailengte a [mm] voor T-FIXX® ①

Draaddiameter / Ankerafmeting		a [mm]
M10	afmetingen	32,0
	M 12 × 50	30,0
M12	M 12 × 70	28,0
	M 12 × 95	
	M 12 × 115	
	M 16 × 60	
M16	M 16 × 80	50,0
	M 16 × 100	
	M 16 × 110	
	M 16 × 125	
	M 20 × 70	
M20	M 20 × 100	44,0
	M 20 × 125	
	M 20 × 145	
	M 20 × 145	

① voor type T-FIXX® (GV, A4)

Maximale indraailengte a [mm] voor boutanker / stekanker ②, ③

Draad-diameter	a [mm]
M12	23,0
M16	29,0
M20	35,0
M24	46,0
M30	60,0
M36	74,0
M42	68,0

② voor de volgende types:

- 1985 (GV)
- 1980-P (GV, FV, A4-80)
- 3016 (GV)
- 3010 (A4-80)
- 1980-S (GV)
- 1988-S (GV)
- 1554 (GV, FV, A4-80)
- 1558 (GV, FV, A4-80)

Draad-diameter	4010/4030	1988*
	a [mm]	a [mm]
M12	-	25,0
M16	25,0	31,0
M20	33,0	37,0
M24	38,0	48,0
M30	48,0	62,0
M36	-	76,0
M42	65,0	70,0

③ voor de volgende types:

- 1988 (GV, FV, A4-50, A4-80)
- 4010 (GV, FV)
- 4030 (GV, FV)

* Voor boutankers met speciale afdichting aan de onderkant van de mof moeten de waarden met 3,0 mm worden verminderd (types A4-50, A4-80).

Maximale indraailengte a [mm] voor schroefhuls ④-⑧

Draaddiameter / Ankerafmeting		a [mm]
M6	M 6 × 30	14,0
	M 6 × 40	20,0
M8	M 8 × 40	18,0
	M 8 × 50	25,0

④ voor type 995-GB (GV)

Draaddiameter / Ankerafmeting		a [mm]
M6	M 6 × 40	25,0

⑤ voor type 995 (A4)

Draaddiameter / Ankerafmeting		a [mm]
M8	M 8 × 50	20,0
M10	M 10 × 50	
M12	M 12 × 60 (GV)	23,0
	M 12 × 60 (A4)	25,0
	M 12 × 70	30,0
M16	M 16 × 70	25,0
	M 16 × 80	
	M 16 × 100 (A4)	
	M 16 × 100 (GV)	
	M 16 × 120	
M20	M 20 × 100	40,0
	M 20 × 120	
M24	M 24 × 120	50,0
M30	M 30 × 150	70,0

⑥ voor de volgende types:

- 995-G (GV, A4)
- 1036-G (GV, A4)

Draaddiameter / Ankerafmeting		a [mm]
M8	M 8 × 50	30,0
M10	M 10 × 60	35,0
M12	M 12 × 45	18,0
	M 12 × 70	40,0
M16	M 16 × 60	24,0
	M 16 × 100	32,0
M20	M 20 × 70	30,0
	M 20 × 100	40,0
M24	M 24 × 80	24,0

⑦ voor de volgende types:

- 1130 (GV)
- 1140 (GV, A4)

Draaddiameter / Ankerafmeting		a [mm]
M12	M 12 × 60	22,0
M16	M 16 × 75	22,0
	M 16 × 100	35,0
M20	M 20 × 90	25,0
	M 20 × 120	45,0
M24	M 24 × 100	30,0
M30	M 30 × 135	35,0

⑧ voor type 995-DG (GV)

English

Deutsch

Français

Español

Nederlands

Polski

Typy kotew

Instrukcja montażu obowiązuje dla następujących typów kotew tulejowych:

T-FIX®
(GV, A4)

**Kotwy pretowe**

Typy 4010 (GV, FV), 4030 (GV, FV), 3016 (GV),
3010 (A4-80), 1980-S (GV), 1988-S (GV),
1554 (GV, FV, A4-80), 1558 (GV, FV, A4-80)

**Kotwy trzpieniowe**

Typy 1988 (GV, FV, A4-50, A4-80), 1985 (GV),
1980-P (GV, FV, A4-80)



Typ1988
Typ1985

Kotwy tulejowe

Typy 995-GB (GV), 995 (A4), 995-G (GV, A4),
995-DG (GV), 1036-G (GV, A4), 1130 (GV), 1140 (GV, A4)



Ogólne wskazówki montażu

Aby zagwarantować dobre połączenie pomiędzy kotwą tulejową a betonem, należy zadbać, żeby kotwa nie była zabrudzona np. olejem. Mieszanke betonową należy starannie rozłożyć unikając bezpośredniego kontaktu buławy wibratora z kotwą. Zalecane jest dodatkowe przywiązanie kotew do zbrojenia.

Kotwy tulejowe umieszczane są w licu powierzchni betonu lub zagłębione. W przypadku kotew zagłębionych, przy montażu elementu mocowanego stosuje się podkładki. Bezpośrednio po rozszalowaniu należy wykręcić talerzyki.

Wnętrze tulei gwintowanej, do czasu zamocowania elementu, należy chronić przed wnikaniem wody, zabrudzeń, oleju. Także po montażu końcowym należy zapewnić, aby do tulei nie wnikała woda.

Do zamocowania elementu budowlanego należy stosować przewidziane przez projektanta śruby.

Minimalne i maksymalne głębokości wkręcenia śrub mocujących w tuleje, jak również maksymalne momenty wkręcenia (T_{inst}) podane są w tabelach na stronach 36 - 37.

Obciążenie kotew tulejowych może nastąpić dopiero po osiągnięciu przez beton przewidzianej wytrzymałości.

Spawalność

Wszystkie stalowe produkty „DEMU FIX” umieszczone w katalogu są spawalne. Jednak każdy rodzaj spawania może negatywnie wpływać na właściwości mechaniczne produktów DEMU.

Jeśli w szczególnych przypadkach zastosowań spawania nie da się uniknąć, należy zwracać uwagę na:

- możliwość wystąpienia ograniczonej funkcjonalności i nośności.
- ewentualne powłoki usunąć przed spawaniem
- należy stosować sprzęt ochronny.
- klient jest odpowiedzialny za dotrzymanie obowiązujących przepisów w zakresie procesu spawalniczego.

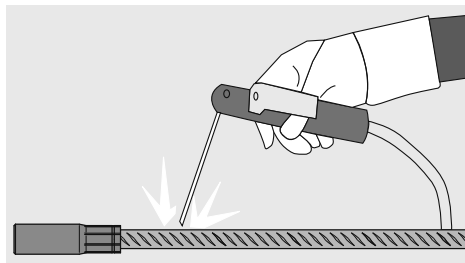

HALFEN nie ponosi odpowiedzialności za szkodę wynikającą z zastosowania produktów, które zostały zesparane.

Montaż osprzętu

Podkładka przytrzymująca
typ 2275 (h=2 mm)



typ 2280 (h= 10 mm)



Dybel montażowy
typ 2250



Zatyczka
typ 2244



Adapter gwintu
typ 2600



Dostępne rozmiary gwintów: M8 – M30

d_{nom}	M8*	M10	M12	M16	M20	M24	M30*
-----------	-----	-----	-----	-----	-----	-----	------

* Dostępny tylko typ 2280

Rysunek 1

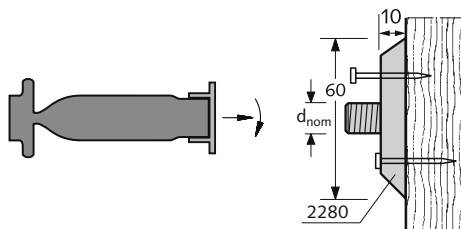

Dostępne rozmiary gwintów: M6 – M24

d_{nom}	M6	M8	M10	M12	M16	M20	M24
\varnothing otworu wierczonego [mm]	11	11	11	11	17	17	17

Rysunek 2

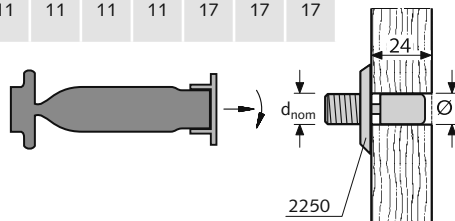

Dostępne rozmiary gwintów: M6 – M42

d_{nom}	M6	M8	M10	M12	M16	M20	M24	M30	M36	M42
-----------	----	----	-----	-----	-----	-----	-----	-----	-----	-----

Rysunek 3

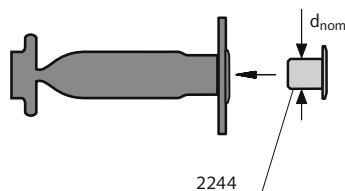

Dostępne rozmiary gwintów: M12 – M42

d_{nom}	M12	M16	M20	M24	M30	M36	M42
d_B śruby	M6	M8	M8	M10	M10	M10	M12

Rysunek 4

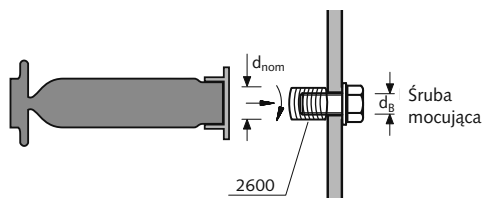

English

Deutsch

Français

Español

Nederlands

Polski

Montaż (ilustracja: T-FIXX; mocowanie innych typów tulei analogicznie)

English

Mocowanie do szalunku

Przygotowanie do montażu

Śrubę wkręcić i dociągnąć^①

Deutsch

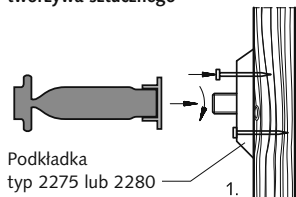
Przypadek A
podkładka przytrzymująca z tworzywa sztucznegoPodkładka
typ 2275 lub 2280

1.

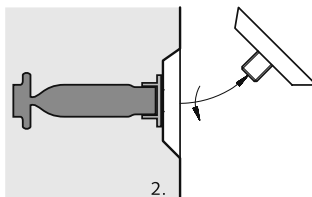

2.

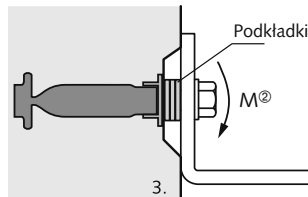

3.

Podkładki

M²

Français

Przybić podkładkę:
patrz str. 33, rys. 1Usunąć szalunek,
wykręcić podkładkę

Español

Przypadek B
montaż przy użyciu dybla do zerwania

Nederlands

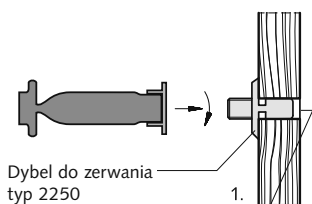
Dybel do zerwania
typ 2250

1.

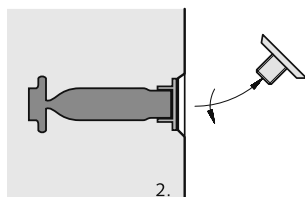

2.

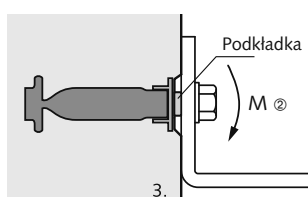

3.

Podkładka

M²

Polski

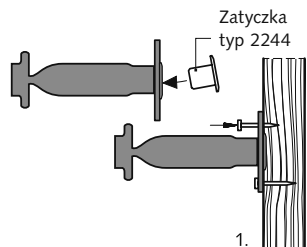
Otwór w szalunku:
patrz str. 33, rys. 2Usunąć szalunek,
wykręcić część gwintowanąPrzypadek C
kotwy tulejowe ze zintegrowanym kołnierzemZatyczka
typ 2244

1.

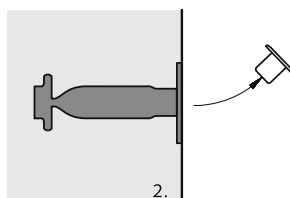

2.

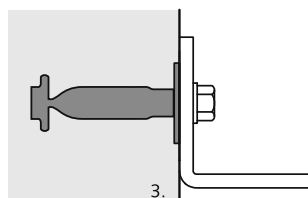

3.

Osadzić zatyczkę w tulei:
patrz str. 33, rys. 3Usunąć szalunek,
usunąć zatyczkę① moment dokręcenia T_{inst} → patrz tabela na str. 36

② należy uwzględnić zginanie śruby na skutek cofniętego położenia kotwy tulejowej (śruby nie są objęte dostawą)

Montaż (ilustracja: T-FIXX; mocowanie innych typów tulei analogicznie)

Mocowanie do szalunku

Przygotowanie do montażu

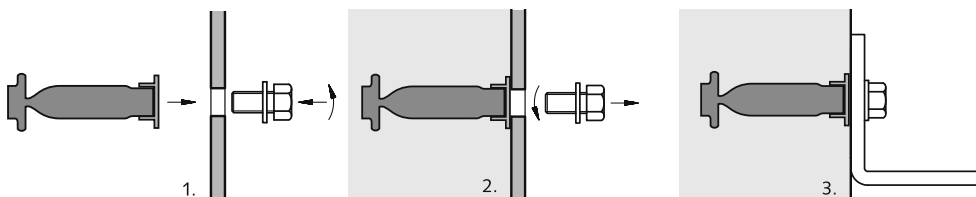
Śrubę wkręcić i dociągnąć^①Przypadek D
ze śrubą sześciokątną

Wykręcić śrubę, usunąć szalunek,
usunąć szalunek

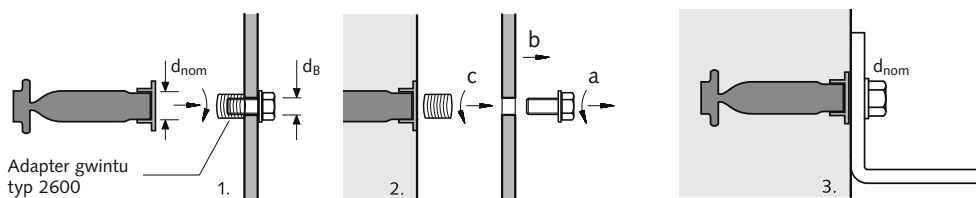
Przypadek E
z adapterem gwintu i śrubą sześciokątną

Adapter gwintu
typ 2600

Zamocować adapter:
patrz str. 33, rys. 4

a) Wykręcić śrubę sześciokątną,
b) usunąć szalunek,
c) wykrocić adapter gwintu

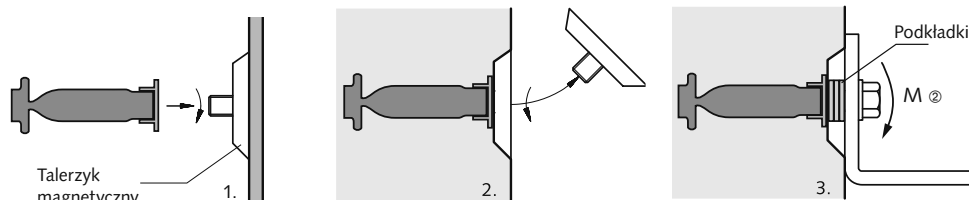
Przypadek F
talerzyk montażowy na szalunku
stalowym

Talerzyk
magnetyczny

Usunąć szalunek,
wykręcić talerzyk magnetyczny

① moment dokręcenia T_{inst} → patrz tabela na str. 36

② należy uwzględnić zginanie śruby na skutek cofniętego położenia kotwy tulejowej (śruby nie są objęte dostawą)

Moment wkręcenia T_{inst} [Nm]*

Rozmiar gwintu	T-FIXX®	Kotwa trzpieniowa/prętowa	Kotwa tulejowa
M10	≤ 8	-	≤ 4
M12	≤ 10	≤ 10	≤ 8
M16	≤ 30	≤ 30	≤ 17
M20	≤ 60	≤ 50	≤ 25
M24	-	≤ 90	≤ 53
M30	-	≤ 180	≤ 96
M36	-	≤ 250	-
M42	-	≤ 300	-

* Momenty obowiązują tylko dla śrub w stanie nie nasmarowanym.

Określenie wymaganej długości śrub

Ogólnie

Element budowlany mocowany jest przy pomocy śruby z gwintem metrycznym, podkładki i nakrętki kontrującej w zabetonowanej kotwie tulejowej. Wymienione komponenty do mocowania nie są zawarte w dostawie i muszą być oddzielnie zamawiane. Należy stosować śruby według wytycznych projektanta.

Długość wkręcenia

Przy stosowaniu kotew tulejowych należy zwracać uwagę na minimalne i maksymalne długości wkręcenia śrub. Minimalne długości wkręcenia zestawiono w tabeli poniżej. Określenie wymaganej długości śrub opisane jest w następnym punkcie.

Określenie wymaganej długości śruby (L_s)Długość śruby (L_s)

$L_{s,min}$ = $s + k$ (minimalna długość śruby)

$L_{s,max}$ = $a + k$ (maksymalna długość śruby)

- k = grubość mocowania (grubość elementu budowlanego i podkładki)
 s = minimalna długość wkręcenia (→ patrz tabela poniżej)
 a = maksymalna długość wkręcenia (→ patrz tabele na str. 37)

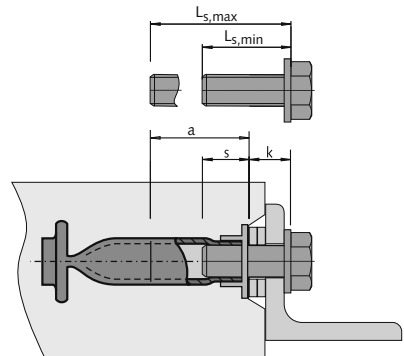
Minimalne długości wkręcenia s [mm]

Rozmiar gwintu	T-FIXX®	Kotwa trzpieniowa 1988	Kotwy trzpieniowe 1985/1980-P / kotwy prętowe / kotwy tulejowe ①,②
M6	-	-	7,2
M8	-	-	9,6
M10	17,0	-	12,0 / 15,0
M12	19,0	16,4	14,4 / 18,0
M16	26,0	21,2	19,2 / 24,0
M20	32,0	26,0	24,0 / 30,0
M24	-	30,8	28,8 / 36,0
M30	-	38,0	36,0
M36	-	45,2	43,2
M42	-	52,4	50,4

① $s = 1,2 \times d_{nom}$

② większe wartości ($s = 1,5 \times d_{nom}$) obowiązują dla kotew tulejowych ze zintegrowanym kołnierzem → typy 1985 (GV), 1036-G (GV, A4) i 1130 (GV).

**Maksymalne długości wkręcenia a [mm]
dla T-FIX® ①**

Rozmiar gwintu / wielkość kotew		a [mm]
M10	wszystkie rozmiary	32,0
	M 12 × 50	30,0
M12	M 12 × 70	28,0
	M 12 × 95	
	M 12 × 115	
	M 16 × 60	
M16	M 16 × 80	50,0
	M 16 × 100	
	M 16 × 110	
	M 16 × 125	
	M 20 × 70	
M20	M 20 × 100	62,0
	M 20 × 125	
	M 20 × 145	

① dla typu T-FIX® (GV, A4)

**Maksymalne długości wkręcenia a [mm]
dla kotew trzpieniowych / kotew prętowych ②, ③**

Rozmiar gwintu	a [mm]
M12	23,0
M16	29,0
M20	35,0
M24	46,0
M30	60,0
M36	74,0
M42	68,0

② dla następujących typów:

1985 (GV)
1980-P (GV, FV, A4-80)
3016 (GV)
3010 (A4-80)
1980-S (GV)
1988-S (GV)
1554 (GV, FV, A4-80)
1558 (GV, FV, A4-80)

Rozmiar gwintu	4010/4030	1988*
	a [mm]	a [mm]
M12	-	25,0
M16	25,0	31,0
M20	33,0	37,0
M24	38,0	48,0
M30	48,0	62,0
M36	-	76,0
M42	65,0	70,0

③ dla następujących typów:

1988 (GV, FV, A4-50, A4-80)
4010 (GV, FV)
4030 (GV, FV)

* dla kotew trzpieniowych typu A4-50, A4-80, wartość należy zmniejszyć o 3mm.

**Maksymalne długości wkręcenia a [mm]
dla kotew tulejowych ④-⑧**

Rozmiar gwintu / wymiar kotwy		a [mm]
M6	M 6 × 30	14,0
	M 6 × 40	20,0
M8	M 8 × 40	18,0
	M 8 × 50	25,0

④ dla typu 995-GB(GV)

Rozmiar gwintu / wymiar kotwy		a [mm]
M6	M 6 × 40	25,0

⑤ dla typu 995 (A4)

Rozmiar gwintu / wymiar kotwy		a [mm]
M8	M 8 × 50	20,0
M10	M 10 × 50	
M12	M 12 × 60 (GV)	23,0
	M 12 × 60 (A4)	25,0
	M 12 × 70	30,0
M16	M 16 × 70	25,0
	M 16 × 80	
	M 16 × 100 (A4)	
	M 16 × 100 (GV)	
	M 16 × 120	
M20	M 20 × 100	40,0
	M 20 × 120	
M24	M 24 × 120	50,0
M30	M 30 × 150	70,0

⑥ dla następujących typów:

995-G (GV, A4)
1036-G (GV, A4)

Rozmiar gwintu / wymiar kotwy		a [mm]
M8	M 8 × 50	30,0
M10	M 10 × 60	35,0
M12	M 12 × 45	18,0
	M 12 × 70	40,0
M16	M 16 × 60	24,0
	M 16 × 100	32,0
M20	M 20 × 70	30,0
	M 20 × 100	40,0
M24	M 24 × 80	24,0

⑦ dla następujących typów:

1130 (GV)
1140 (GV, A4)

Rozmiar gwintu / wymiar kotwy		a [mm]
M12	M 12 × 60	22,0
M16	M 16 × 75	22,0
	M 16 × 100	35,0
M20	M 20 × 90	25,0
	M 20 × 120	45,0
M24	M 24 × 100	30,0
M30	M 30 × 135	35,0

⑧ dla typu 995-DG (GV)

English

Deutsch

Français

Español

Nederlands

Polski

English

Deutsch

Français

Español

Nederlands

Polski

CONTACT HALFEN WORLDWIDE

HALFEN is represented by subsidiaries in the following countries, please contact us

Austria	HALFEN Gesellschaft m.b.H. Leonard-Bernstein-Str. 10 1220 Wien	Phone: +43-1-2596770 E-Mail: office@halfen.at Internet: www.halfen.at	
Belgium / Luxembourg	HALFEN N.V. Borkelstraat 131 2900 Schoten	Phone: +32-3-6580720 E-Mail: info@halfen.be Internet: www.halfen.be	Fax: +32-3-6581533
China	HALFEN Construction Accessories Distribution Co.Ltd. Room 601 Tower D, Vantone Centre No.A6 Chao Yang Men Wai Street Chaoyang District Beijing · P.R. China 100020	Phone: +86-1059073200 E-Mail: info@halfen.cn Internet: www.halfen.cn	Fax: +86-1059073218
Czech Republic	HALFEN s.r.o. Business Center Šafránkova Šafránkova 1238/1 155 00 Praha 5	Phone: +420-311-690060 E-Mail: info@halfen.cz Internet: www.halfen.cz	Fax: +420-235-314308
France	HALFEN S.A.S. 18, rue Goubet 75019 Paris	Phone: +33-1-44523100 E-Mail: halfen@halfen.fr Internet: www.halfen.fr	Fax: +33-1-44523152
Germany	HALFEN Vertriebsgesellschaft mbH Liebigstr. 14 40764 Langenfeld	Phone: +49-2173-9700 E-Mail: info@halfen.de Internet: www.halfen.de	Fax: +49-2173-970225
Italy	HALFEN S.r.l. Soc. Unipersonale Via F.lli Bronzetti N° 28 24124 Bergamo	Phone: +39-035-0760711 E-Mail: tecnico@halfen.it Internet: www.halfen.it	Fax: +39-035-0760799
Netherlands	HALFEN b.v. Oostermaat 3 7623 CS Borne	Phone: +31-74-267 1449 E-Mail: info@halfen.nl Internet: www.halfen.nl	Fax: +31-74-267 2659
Norway	HALFEN AS Postboks 2080 4095 Stavanger	Phone: +47-51823400 E-Mail: post@halfen.no Internet: www.halfen.no	
Poland	HALFEN Sp. z o.o. Ul. Obornicka 287 60-691 Poznan	Phone: +48-61-622 1414 E-Mail: info@halfen.pl Internet: www.halfen.pl	Fax: +48-61-622 1415
Spain	HALFEN IBERICA, S.L. Poligono Industrial Santa Ana c/ Ignacio Zuloaga 20 28522 Rivas-Vaciamadrid	Phone: +34-91 632 18 40 E-Mail: info@halfen.es Internet: www.halfen.es	Fax: +34-91 633 42 57
Sweden	Halfen AB Vädursgatan 5 412 50 Göteborg	Phone: +46-31-985800 E-Mail: info@halfen.se Internet: www.halfen.se	Fax: +46-31-985801
Switzerland	HALFEN Swiss AG Hertistrasse 25 8304 Wallisellen	Phone: +41-44-8497878 E-Mail: info@halfen.ch Internet: www.halfen.ch	Fax: +41-44-8497879
United Kingdom / Ireland	HALFEN Ltd. A1/A2 Portland Close Houghton Regis LU5 5AW	Phone: +44-1582-470300 E-Mail: info@halfen.co.uk Internet: www.halfen.co.uk	Fax: +44-1582-470304
United States of America	HALFEN USA Inc. PO Box 18687 San Antonio TX 78218	Phone: +1 800.423.9140 E-Mail: info@halfenusa.com Internet: www.halfenusa.com	Fax: +1 877.683.4910
For countries not listed HALFEN International	HALFEN International GmbH Liebigstr. 14 40764 Langenfeld / Germany	Phone: +49-2173-970-0 E-Mail: info@halfen.com Internet: www.halfen.com	Fax: +49-2173-970-849

Furthermore HALFEN is represented with sales offices and distributors worldwide.
Please contact us: www.halfen.com



NOTES REGARDING THIS DOCUMENT

Technical and design changes reserved. The information in this publication is based on state-of-the-art technology at the time of publication. We reserve the right to make technical and design changes at any time. HALFEN GmbH shall not accept liability for the accuracy of the information in this publication or for any printing errors.

The HALFEN GmbH subsidiaries in Germany, France, the Netherlands, Austria, Poland, Switzerland and the Czech Republic are Quality Management certified according to **ISO 9001:2015**, Certificate no. 202384-2016-AQ-GER-DAKKS.



